



Mission accomplished



Cleanzone 2018 draws more international visitors to Frankfurt

With over 38 percent of its visitors coming from outside Germany, Cleanzone demonstrated once again this year that it is Europe's platform for cleanroom technology (2017: 35 percent). The number of participants also increased compared to the previous event, with nearly 1,300 cleanroom technology experts from 39 countries discussing the latest innovations and trends over two days in Frankfurt.* The trade fair for cleanroom technology had even more on offer this year with over 30 percent more exhibition space than in 2017.

Cleanzone increased the international share of visitors to more than 38 percent this year. For the first time, potential customers who travelled to the trade fair in Frankfurt am Main included visitors from countries such as Korea, Japan and Indonesia. The number of visitors from Great Britain and Turkey increased markedly. A total of 78 companies from ten countries presented their innovations and trends in over 30 percent more exhibition space in Hall 5.1 at Messe Frankfurt. Iris Jeglitza-Moshage, Senior Vice President of Messe Frankfurt: "With its large international component, Cleanzone 2018 is the most important trade fair for cleanroom technology in Europe. We are delighted by the positive feedback from our exhibitors regarding our efforts to advertise this event internationally."

Visitors included representatives from Infineon, Continental Automotive, Bosch, Bayer, Carl Zeiss, Fre-

senius Kabi, BASF, Sanofi Aventis, the German Cancer Research Center (DKFZ), Mainz University Hospital and the Max Planck Institute. The trade fair's expanded range was a hit, with 84 percent of all visitors (2017: 83 percent) and 88 percent of German trade visitors (2017: 82 percent) expressing satisfaction with what was on offer. Furthermore, 71 percent of all visitors (2017: 67 percent) and 81 percent of German participants (2017: 80 percent) agreed that the mood in the industry is positive.

Cleanzone is the industry's forum for innovation, and the trade fair was once again focused on new products and services that offer digital and flexible solutions for the cleanrooms of tomorrow. There was a particular focus on process simulations conducted in advance, training using virtual reality, methods for automatic and robot-controlled disinfection, various aspects of data and counterfeit protection, and flexible cleanroom

Mission accomplished: Cleanzone 2018 draws more international visitors to Frankfurt

modules that can be set up quickly.

The Cleanroom Award, which was presented for the seventh time this year, went to KEK, stainless steel specialists in Saxony, for their convenient and easy-to-fold table for temporary use.

Frank Duvernell, Managing Director of ReinraumAkademie (Leipzig) and partner of Cleanzone: "Be it digitalisation, virtual reality or new business models, Cleanzone 2018 succeeded in illuminating the themes that are important to the industry's future. New ideas were also supplied by the high-quality supporting programme and the speakers' visions for the future."

Cleanroom solutions for state-of-the-art biopharmaceuticals, utilisation of the building information modelling (BIM) method for planning industry production facilities, new disinfection processes and the requirements for hospital pharmacies were some of the highlights at the Cleanzone Conference. At the Cleanzone Plaza event stage, experts discussed cleanroom technology 5.0, the Russian pharmaceutical market, and data and counterfeit protection, while the German Cleanroom Institute (DRRI), Austrian Cleanroom Society (ÖRRG) and a group of companies associated with mycleanroom.de presented their products and services at a large joint stand.

Besides Germany, the most important visitor countries included the Netherlands,

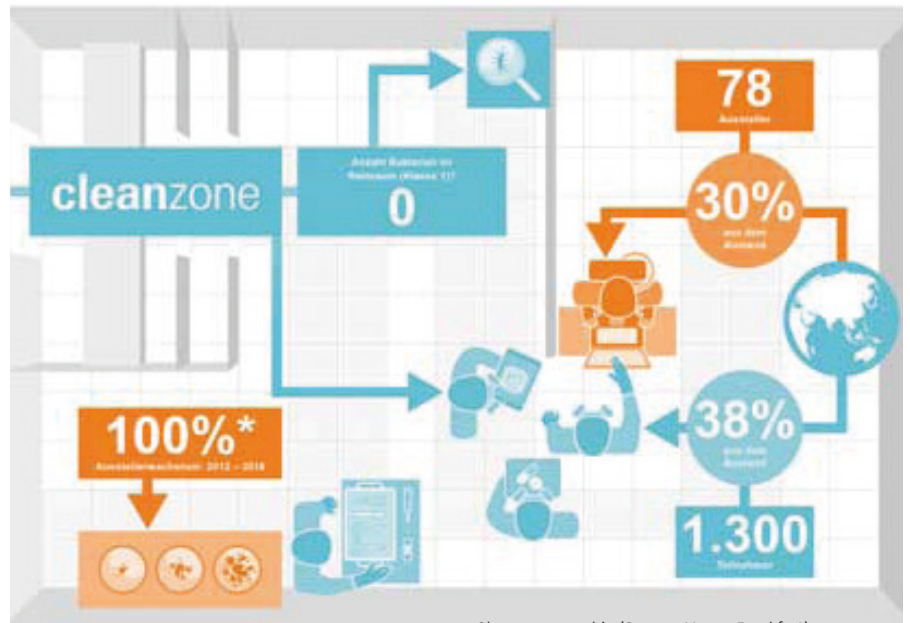

Cleanzone graphic (Source: Messe Frankfurt)

Switzerland, Ireland, Austria, Great Britain, the Russian Federation, China, France and Denmark. Cleanzone's trade visitors came from every industry where production is carried out under cleanroom conditions, including the automotive, semiconductor, aerospace, laser, optics, surface technology, food and pharmaceuticals industries, hospitals and pharmacies.

*2017: 1,200 participants from 40 countries

cleanzone

cleanzone

Messe Frankfurt Exhibition GmbH

Ludwig-Erhard-Anlage 1

D 60327 Frankfurt am Main

Telefon: +49 69 7575 6290

Telefax: +49 69 7575 96290

E-Mail: anja.diete@messefrankfurt.com

Internet: <http://www.messefrankfurt.com>

19th - 20th November 2019: CLEANZONE 2019, Frankfurt am Main (D)





Dear cleanroom professionals and interested parties,

Cleanzone 2018 was also a success for us as exhibitors. Already the first impression was good, we liked the clear and concise structure as well as the generous design of the areas. But we were also impressed by the broad range of exhibitors from the fields of plants, construction, consulting, floors, filters, measuring technology, training and consumables.

Thematically, we were fascinated by Virtual Reality (VR), which has now arrived massively in the industry and provides new worlds of experience and knowledge in the areas of training and documentation, for example.

As an exhibitor of the first hour, we met many „good old acquaintances“ again this year and held valuable discussions. But also and especially the many new contacts have inspired us to position ourselves with cleanroom online once again as an indispensable information platform.

We are pleased to note that the classic print medium evidently still plays a heavy role in the cleanroom industry. In our case this can be taken literally, as our popular yearbook with its 2018 edition weighs in well at 830 grams. We regard it as proof of its legitimacy that the edition was literally ripped from our hands. In particular, industry „newcomers“ were interested in this compendium with many background articles and concentrated basic knowledge and they wanted to take it home with them.

During the numerous conversations it became clear that the yearbook is circulated in many companies in order to give new employees a first overview of the industry, to keep the „old hands“ up to date and to display the compendium for visitors at the end of the circulation. We think this is good practice and can only recommend it for imitation.

We hope you enjoy reading our newsletter and look forward to your feedback.

Yours sincerely,

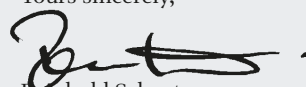
Reinhold Schuster

Series production of Gx RTF Clearject plastic syringes started

Gerresheimer produces high quality COP syringes in Germany

The pharmaceuticals and health care specialist Gerresheimer has commenced with series production of the new Gx RTF Clearject syringes. The products of the high performance plastic COP (Cyclo Olefin Polymer) are used where especially sophisticated medications need to be packaged. The new Gx RTF Clearject syringe 1 ml long with cannula is the first plastic syringe developed and produced by Gerresheimer itself.

Gerresheimer brought together its comprehensive competence in glass production at the Bünde location and the expertise of its plastic specialist in the Technical Competence Center (TCC) Wackersdorf for the development and industrialization of the new syringe. The production facility was thus planned and built by the automation team of the Technical Competence Center; the know-how for the quality control and quality guidelines for primary packaging originates from the inspection specialists of the glass location Bünde, and was adapted jointly to the specific requirements of plastic production. Production takes place pursuant to the especially high quality requirements for pharmaceutical primary packaging material corresponding to GMP. The new production facility is conceived in such a way that the entire processing chain from injection molding to finished RTF packaging is covered. A series of cameras were installed at various stations for quality control, with which all relevant geometrical parameters and cosmetic-visual defects are checked for each individual product.

Innovative medications mean strict requirements for their primary packaging. Especially biotechnologically manufactu-



The cannula is insert-molded during the injection molding procedure. The syringe is free of tungsten and glue.



Production in the clean room according to GMP Grade C of the pre-fillable plastic syringe with cannula.

red active agents may not interact with the packaging, because this could mean undesirable effects for patients. Gx RTF ClearJect syringes offer especially low interaction potential. The material COP has a high pH tolerance, does not emit metal ions into the medication solution, and therefore causes no displacement of the pH value while in storage. The syringe is manufactured as an injection molding part in an 8-fold hot runner mold. The cannula is also thereby injected at the same time and does not need to be retroactively glued in. Tungsten and glue residue is therefore eliminated with the Gx RTF ClearJect syringes. The precise geometry of the injection molding part reduces the dead volume in the syringe, leaving behind less of the expensive medication in the syringe. Also attractive is the increased safety for the end consumer. COP is particularly break-resistant, making it suitable

for packaging aggressive or toxic materials.

The new Gerresheimer Gx RTF ClearJect COP syringe is available in the long 1 ml size with cannula. The design corresponds to ISO 11040-6. The first version of the syringe is equipped with a 27-gauge, 1/2-inch (12.7 mm), and thin-walled stainless-steel needle with three bevels. The syringes are siliconized with a precisely controlled amount of high-viscosity, and thus low-particle Dow Corning 360 MD (12,500 cSt) silicone oil, offering a comprehensive syringe system that completes the COP syringe body with plunger rods, plunger stoppers, finger flange, and closure systems. An economically efficient complete solution is achieved through the use of commercially available standard components.



The new Gx RTF Clearject plastic syringe.

Satisfying the requirements for modern assembly systems

Intelligent feeding solutions - An increased emphasis on flexibility, efficiency and technical cleanliness

The year 1908 was one of the most historically significant years both for personal motorised transport and for industrial assembly. With the Model T, the Ford Motor Company launched an automobile on the market which could be manufactured for the first time in large numbers at an affordable price. This not only heralded the age of private transport for the masses, but this first assembly line also gave the green light to industrial series production in the automotive industry. Due to advancing rationalisation measures, amongst other things in the form of a comprehensive division of labour, production rose to the point where it was efficient enough to produce up to 9000 vehicles a day.

Since then, despite an enormous increase in output, the basic principle of manual assembly work has essentially remained the same. Product assembly has been



Vibratory bowl feeder eacy feed

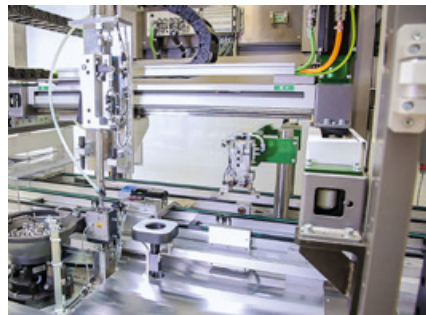

Pick-and-Place

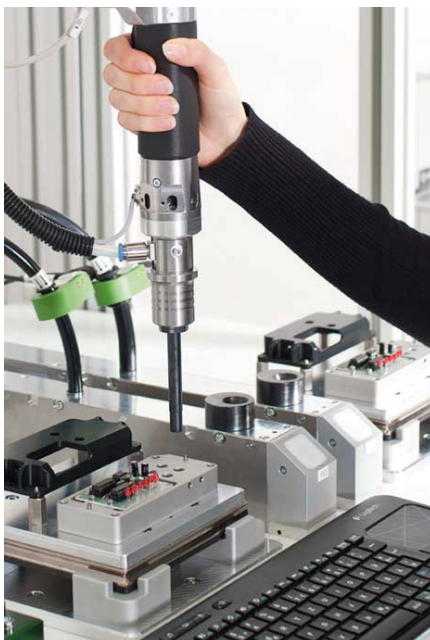

Sword Feeder



revolutionarily influenced by an increase in automation and digitalisation. Today, fully automatic systems can be remotely operated thanks to intelligent, Industry 4.0 capable hardware and software components and are interconnected with correlating systems, linked by feeding technology. An assembly system component can be fed and positioned, whilst at the same time fasteners such as screws or nuts are sorted, correctly positioned, separated and fed directly into the screwdriving tool – and all in the



Inverted screw assembly unit

Satisfying the requirements for modern assembly systems

blink of an eye. However, changes in relevance to current or future influencing factors or constantly developing requirements still relentlessly force the industry to come up with new enhancements.

One of the most relevant of these factors is the advancement of miniaturisation. Today, modern processors of just a few square millimetres are equipped with many billions of transistors. Most dirt particles appear huge in comparison to such small structures on the nanometer scale, and depending on the application, can pose a significant risk. For example, even the smallest conductive particles can cause a short circuit in electronic components. Material particles from carbon fibre reinforced plastics are conductive so the use of these new and more efficient materials actually heightens this risk. Therefore, the increased relevance of technical cleanliness goes hand in hand with miniaturisation.

DEPRAG SCHULZ GmbH from Amberg, Germany, is one of the global market leaders in the field of automated screwdriving and feeding technology. Their recipe for long-term success is the continued drive for evolution and innovation, combined with the development of intelligent and efficient system solutions. With this in mind, DEPRAG Schulz GmbH developed their complete CleanFeed concept with specific CleanFeed components to meet the requirements for technical cleanliness in feeding. It includes elements for low abrasion part feeding to minimise the generation of damaging particles from the outset. Low abrasion sword feeders are particularly gentle at sorting, separating and supplying fasteners. Sensors on the device automatically determine the number of strokes necessary so that stroke movement and therefore abrasion is kept to a minimum. Furthermore, hoppers help to keep a consistently low quantity of fasteners in the feeding system because fewer screws mean less contamination. However, because the generation of particles cannot be entirely eliminated, suction systems are also an effective method of creating cleanroom conditions. The DEPRAG "Particle Killer" targets and removes dirt particles before assembly and ejects them through a filter. The DEPRAG SFM-V vacuum screwdriving module on the other hand, uses suction to remove residual dirt directly from the screwdriving tool via additional vacuum sources. As well as modi-

fications to the hardware, particle contamination is also combatted by intelligent adjustments managed by the controller, such as a reduction in speed during bit engagement with the screw head, at the same time averting wear and tear on the tool.

Efficiency has always been a vital aspect for the entire supply chain in economical assembly systems. The DEPRAG vibratory spiral feeder easy feed provides a particularly effective drive concept. Both the controller and drive of this efficient feeder are based on a power supply of 24 V/DC. Using oscillating magnets in the feed bowl, this is sufficient to trigger periodic oscillating motions and attain an energy saving of around 80%. The use of a universal power supply unit allows worldwide application of the device without modifications. Furthermore, the intelligent PFC100 controller allows for customised settings without time-consuming mechanical intervention. If assembly should be automated to the highest degree possible, but quantities do not justify a fully automatic feeding system, then a screw presenter offers an inexpensive, compact and quickly implemented solution. Screw presenters can be modified for different screw sizes with just a few steps, they are gentle on components, can be utilised in handheld or stationary applications and are fully self-sufficient thanks to their integrated controller.

Today, the global market situation is more dynamic than ever. New products reach the market quicker and the capacitive future of products is not always predictable. A lack of empirical data and uncertainties are the norm in quantity planning for the E-mobility sector. These circumstances require the most flexible solutions possible with short reaction times as is the case in hybrid assembly systems with a combination of manual and automated processes. In this way production can be expanded as necessary through the implementation of intelligent manual work stations without

sacrificing processing reliability. The operator is taken step by step through the assembly task. Sensor technology activates the correct parameters for each screw position, releases fasteners, notifies the operator of subsequent tasks and evaluates results. The Pick-and-Place procedure guides the operator by picking up the correct fasteners and precisely directing them to the correct screw position. Assembly remains both flexible and reliable. One of the greatest challenges for hybrid assembly systems is the pairing of man and machine who do not always work at the same tempo. The solution is creating buffer zones, using intelligent linear conveyors. This enables larger distances to be bridged as well as controlling part flow. Depending on requirements, the conveyors provide part buffers or separate the part flow. Another measure in attaining highest flexibility is the use of modular system concepts with standardised components. DEPRAG has a comprehensive module portfolio including sensor-controlled screwdrivers, feeding systems, controllers etc., all from a single source. These individual modules are already coordinated with each other, thereby saving time and effort in integration. The high flexibility means that assembly systems can be quickly adapted to the current market situation; countering planning uncertainties and quickly reacting to changing requirements.

Henry Ford's own intelligent and efficient ideas shaped his production so that it was as economical as possible. For ten years, his company produced only black body parts and obligated suppliers to deliver precisely dimensioned wooden shipping containers whose boards were then taken apart to be used in vehicle construction. Such measures may be unthinkable today, however the objective of realising efficient, intelligent system solutions still holds true. Assembly systems are complex, perfectly coordinated interdependent systems comprising of numerous components. A system malfunction in feeding technology can cause a delay to larger parts in the supply chain and thereby create far-reaching financial and organisational consequences. With their widely diversified component portfolio designed to satisfy any requirement, DEPRAG Schulz GmbH provides flexible and reliable options for the realisation of highly profitable assembly systems.

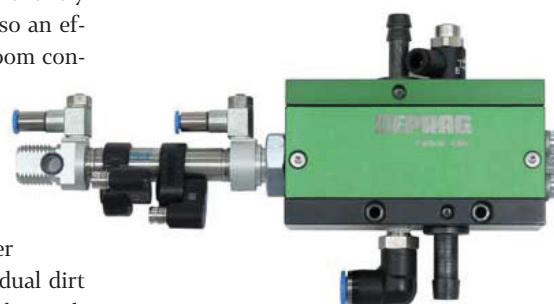

Particle Killer

Flexible solutions for packing medical products

At Compamed 2018 MULTIVAC will be presenting an innovative packaging concept for medical and pharmaceutical products, which offers users a novel opening aid for easy product removal. In addition to this, MULTIVAC is also featuring at the trade fair a number of other packaging solutions, which enable medical products to be packed flexibly, efficiently and with a very high level of process reliability.

With Snapsil® MULTIVAC is showing a novel packaging concept for medical and pharmaceutical products, which is ideally suited to packing products such as syringes, tablets, plasters, injectors, catheters etc. With their integrated „snap-opening“ function, Snapsil packs offer an innovative opening aid, which enables the packs to be used more easily, even by elderly or disabled persons. When it comes to the hectic activity of everyday life in hospitals and care homes, it is simple and quick to open the packs and remove the product easily in a controlled way. Depending on the type of product, the pack can be equipped with a „click-to-close“ function, so that it can be opened again for multiple use and then closed securely. In addition to this, tamper-proof protection offers the maximum product safety. Snapsil packs can be produced on MULTIVAC thermoforming packaging machines and traysealers. The solution was developed in conjunction with the Snapsil Corporation.

MULTIVAC will also be presenting an automated packaging line for packing sterile medical products. The line consists of a R 245 thermoforming packaging machine with a syringe infeed system, a thermal transfer printer for printing variable production data on the packs, and a visual inspection system for inspecting the print image. The R 245 thermoforming packaging machine can be freely configured and offers a high level of flexibility as regards packaging materials and pack formats. At Compamed it is equipped with an automatic infeed system for loading prefilled glass or plastic syringes, and the system inspects the products before inserting them securely into the pack cavities. The infeed system consists of a shaft infeed system, a separating wheel, a transport conveyor and a pick & place robot. All the components of the infeed system are synchronised with the thermoforming packaging machine, and they can be operated via its control terminal in a convenient and reliable way.

The exhibits will also include a R 081 thermoforming packaging machine, a compact model for small-scale production and for those companies, which want to start on automated packaging. The machine can be used for producing both vacuum packs and modified atmosphere packs with reduced residual oxygen content. Flexible and rigid films as well as Tyvek® and paper-based packaging materials can be run with ease. The range of pack formats can be freely configured. The drawer system ensures that format change is fast and simple.

As regards the traysealer sector, MULTIVAC will be presenting the T 260, which was specially developed to meet the high demands of the medical products and pharmaceutical industries. This mobile and compact model is designed for running a wide spectrum of trays, and it offers companies packing small to medium-sized

batches a high degree of process reliability, reproducibility and above all flexibility. The sealing die ensures that a controlled sealing pressure and precise temperature distribution are achieved. Critical parameters are monitored permanently by sensors.

The C 300 TC chamber machine will be on show from MULTIVAC's wide range of chamber machines. It enables sterile medical products to be packed securely in film pouches, and packs can be produced either as vacuum packs or with modified atmosphere and reduced residual oxygen content. A temperature-controlled and permanently heated sealing bar, which can be both validated and calibrated, ensures that this cleanroom-compatible machine achieves reproducible sealing quality.



Gx Elite Vials – High Quality and Filling Performance

The Gx Elite vials have set new standards for type 1 borosilicate glass vials. They are the result of comprehensive optimization measures in the conversion process, which have focused on designing out the risk to create product flaws during production including the removal of all glass-to-glass- or glass-to-metal-contact beginning with the tubing material all the way through final packaging. The chemical composition of the borosilicate glass still stays the same.

The best in its class

“The Gx Elite vials are the result of several years of careful product development and our customers are really impressed with them too,” says Hans-Ulrich Pieper, Sales Director Europe Tubular Glass Converting at Gerresheimer, emphasizing just how much of an impact avoiding glass-to-glass contact during the production process has on the quality of the vials. The highly shatter-resistant vials are extremely durable and free of cosmetic defects. They also boast an incredibly robust structure, while their resistance to delamination protects the drug inside. Simple handling and a range of packaging options ensure that Gx Elite vials can be supplied for end-to-end use on various filling lines. This cuts costs while improving quality, as countless past and ongoing tests by notable customers have shown.

Intelligent defect recognition

All of Gerresheimer’s tubular glass plants that produce vials work with standardized monitoring, inspection, and packaging technologies, which essentially comprise the Gx G3 and Gx RHOC systems. The inspection systems, for one, are developed in house and form part of a close-knit testing system that ensures the highest precision and quality assurance in line with the latest standards. Complete with modern HD cameras, the Gx G3 inspection system makes sure that cosmetic defects are identified reliably, for instance. The intelligent software detects and classifies the defects in a few fractions of a second, while the Gx RHOC system ensures dimensional quality with HD matrix cameras and a hypercentric ID camera.

Injection vials set the benchmark for primary packaging for

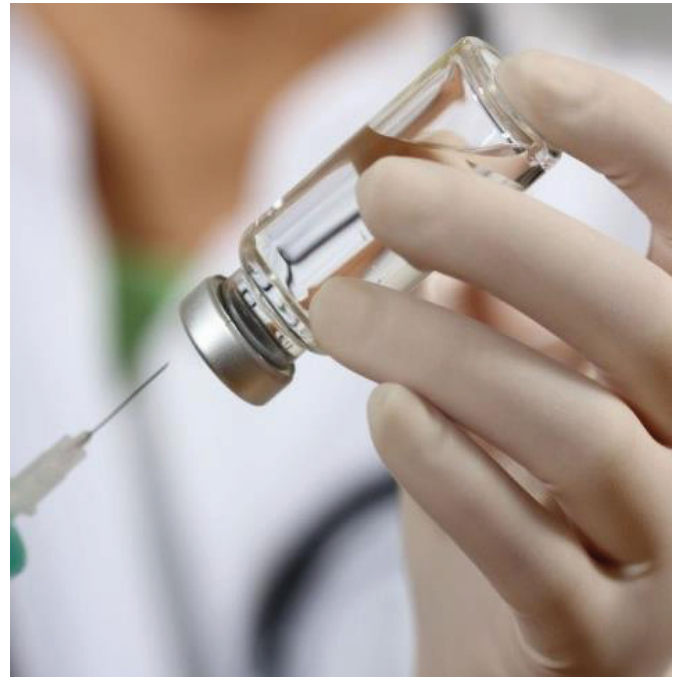

parenteral drugs. Gerresheimer’s vials come in all sizes and comply with the relevant international standards and pharmacopoeias. The company’s range includes solutions for bioengineered drugs and other specialist pharmaceuticals.

Gerresheimer AG
D 40468 Düsseldorf

Compression Testing

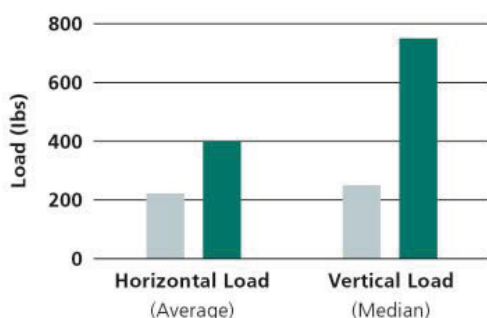

Sidewall Impact Testing

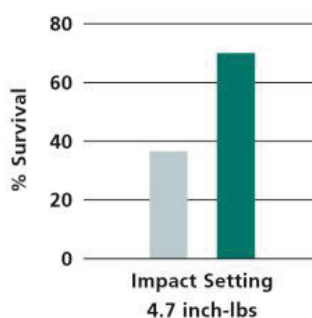

Gx Elite vials are a step up from standard products, performing significantly better in compression and side impact tests.

Arburg Srl: 25 years of success in Italy

- Italian subsidiary celebrates silver anniversary
- Managing Partner Juliane Hehl presents anniversary sculpture
- First-class technology, expert consulting and continuity as the cornerstones of success

The Italian Arburg subsidiary celebrated its 25th anniversary in style from 20 to 22 September 2018. The celebrations were launched with an exclusive evening event attended by more than 160 guests, during which Managing Partner Juliane Hehl presented the traditional anniversary sculpture to Björn Norén, Managing Director of Arburg Srl. On the following two days, an open house event was held with exhibits, applications and expert presentations for customers and partners, followed by another for the employees and their families.

The historic Casale la Colombare estate in Castell'Arquato provided the perfect backdrop for an exclusive celebration of the 25th anniversary of the Italian subsidiary. The highlight of the evening event was the ceremonial presentation of the traditional Arburg anniversary sculpture by Managing Partner Juliane Hehl. With this gesture, she thanked Björn Norén and his team for their great commitment on behalf of the owner families and of the entire Arburg parent company.

Arburg Italy combines continuity with competency

In her speech, Juliane Hehl was especially impressed by the subsidiary's dynamic development in recent years: „Arburg Italy has long been the undisputed leader among our European subsidiaries. Accordingly, the team has more than doubled in size.“ She went on to express her delight that five of the original employees, including Björn Norén, have remained faithful to Arburg Srl over the years. This continuity, she explained, is combined with a high level of expertise – a factor which the customers in Italy value very highly and is an important element in the success of Arburg's Italian subsidiary.



Highlight of the anniversary celebration: Managing Partner Juliane Hehl (r.) presents the traditional anniversary sculpture to Björn Norén, Managing Director of Arburg Srl. (Photo: ARBURG)

Long-standing, trusting and successful cooperation

Managing Director Sales Gerhard Böhm also underlined this aspect in his speech and thanked the customers for the trust they have placed in the company: „The success of our Italian subsidiary is first and foremost due to you, our customers, who for decades have opted for us and our technology and with whom we have jointly implemented countless innovative projects.“

The silver anniversary, he added, clearly confirms that Arburg was on the right track with the foundation of a fully owned subsidiary in Italy a quarter of a century ago. „This was a significant milestone and an important step for the successful development of our company in Italy – our largest European market!“, said Gerhard Böhm, who gave a brief account of the company's history. Björn Norén followed this up by showing a compilation of numerous photos from the past 25 years, with which he took the guests on an entertaining trip down memory lane.

Decades of success on the market in Italy

Arburg's success story in Italy began long before the subsidiary was founded. Shortly after Arburg began serial production with its first injection moulding machine in 1956, Borje Norén, father of the present subsidiary manager Björn Norén and founder of Sverital, made contact with Arburg's owners Eugen and Karl Hehl. A short time later, successful machine sales started in Italy and Sverital became Arburg's official trading partner in 1960. The continued positive development of the Italian market led to the foundation of the Arburg Srl subsidiary in Peschiera Borromeo, near Milan in 1993 in order to better and more fully serve Italian local customers.

The many years of trustful cooperation between Sverital and Arburg also bore fruit in the seamless transition from trading partner to fully owned subsidiary. Björn Norén was appointed as subsidiary manager and 15 further Sverital employees who had previously been responsible for the servicing and sale of the Arburg machines were hired.

Specialist for demanding tasks

With a workforce of 38 employees and 14 sales representatives for nine sales areas, the Italian subsidiary enjoys a very healthy position today. Arburg Srl. is regarded as a specialist for demanding plastic processing tasks. This applies, for example, to multi-compo-

Arburg Srl: 25 years of success in Italy

ment, LSR and powder injection moulding, to high-end packaging and medical technology applications as well as to industrial additive manufacturing with the Freeformer.

Furthermore, many Italian injection moulding companies have upgraded their production in recent years and are increasingly taking on board the topic of Industry 4.0 with Arburg as a partner.

Comprehensive service and consulting offerings

The customers in Italy value the all-round package offered by Arburg Srl: the expert hotline and the highly skilled service technicians provide prompt assistance by phone and on-site. Further offerings include a full range of support from application technology consulting and the configuration of machines and robotic systems, through to commissioning and process optimisation. The showroom at the subsidiary with space for up to six Allrounder injection moulding machines is available for trials and training purposes. The offerings are rounded off with an extremely well-stocked spare parts store and a wide range of training courses and seminars. Over the years, the cooperation with Sverital has also further intensified so that the company is today a major partner for automated turn-key solutions.

Open-house events for customers and employees

To appropriately celebrate „25 years of Arburg“ and to present the company’s products and services live, the exclusive evening event was followed by two open-house events at the subsidiary building in Peschiera Borromeo. Whereas on Friday nearly 80 customers and partners had an opportunity to find out about current topics on the basis of exhibits, applications and expert presentations, the subsidiary threw open its doors to all employees and their relatives on Saturday.

Afterwards, Björn Norén was completely satisfied: „It was an intensive 3-day event and in all cases we got the feeling that ARBURG is not only a machine supplier, but a long-term stable partner whose top priority are the needs of the customers.“

ARBURG GmbH + Co KG
D 72290 Loßburg

SIGMA Certified with Quality Seal “Innovative through Research” anew

SIGMA Engineering GmbH was again awarded with the quality seal “Innovative through Research” by the “Stifterverband für die Deutsche Wirtschaft”. The seal shows the Stifterverband’s appreciation of researching companies in Germany.

In September 2018 SIGMA Engineering GmbH, Aachen, Germany, again received the quality seal “Innovative through Research”. In continuity of the past years, SIGMA was certified as company with a strong commitment to research and development by the “Stifterverband für die Deutsche Wirtschaft”. Since the first award

in 2014, SIGMA belongs to the circle of awarded companies.

To continuously improve the SIGMA-SOFT® Virtual Molding Technology, SIGMA is regularly engaged in research projects and works in close cooperation with universities as well as research institutes. “As technology driven company the continuous development of our software is very important to us. Only with this approach we can provide a product to our customers, which supports them in their daily challenges. For this reason we fully invest our revenue into development to encourage innovations”, explains Timo Gebauer, SIGMA’s CTO.

But SIGMA not only works in close cooperation with universities and research facilities, it is also actively involved in a number of associations. “The various meetings of the associations are an important opportunity to discuss up-to-date development

topics with the industry as well as research facilities. Here we can learn more about the current situation of the plastic processing industry and which current challenges it is facing. And by doing so, we learn in which fields our development is of special importance to further improve plastics technology”, adds SIGMA General Manager, Thomas Klein.

The quality seal “Innovative through Research” appreciates SIGMA’s commitment in these areas. “The needs of our customers provide our company with the motivation to remain active in research and to further improve our product. We continuously invest in the development of our technology to promote innovations in injection molding”, concludes Mr. Klein.



SIGMA Engineering GmbH
D 52072 Aachen

At high speed into the future – GEMÜ founds new start-up in evvo solutions

On 1st October 2018, the Ingelfingen-based valve expert GEMÜ celebrated the foundation of its new subsidiary in evvo solutions.

As the proven CONEXO software system promises to show potential outside the valve market as well, GEMÜ has decided to coordinate activities for other target markets by setting up an independent spin-off. „The technological change that goes hand in hand with digitization presents medium-sized companies with great challenges, but also offers many opportunities. Those companies that meet these changes courageously and resolutely and adapt their business models to the opportunities offered by the market will enjoy long-term success,“ says Gert Müller, Managing Partner at GEMÜ and initiator of the in evvo solutions start-up.

The CONEXO system, which was developed

by GEMÜ, has been successfully used on the valve market for some time now. Components equipped with RFID chips provide electronic support to users during a wide variety of maintenance and service tasks. Using an RFID reader, the CONEXO pen, any and all essential data can be read and directly called up in the system. In this way, the entire maintenance process becomes more transparent and easier to document.

Combining RFID chips with a digital maintenance infrastructure is highly effective wherever strict requirements are placed on documentation – not just within the valve sector.

The in evvo solutions team is made up of qualified software, mechanical and industrial engineers. The young start-up specializes in complete RFID system solutions in industrial environments and will market the CONEXO system in future. As a newly founded company, in evvo solutions will enjoy the necessary organizational independence, while still being able to benefit from the GEMÜ Group's expertise in development, application and manufacturing. The flat organizational structures and agile processes enable the start-up to react to customer requirements quickly and flexibly.

„The foundation of in evvo solutions is an important step for the GEMÜ Group. All those involved pulled together and worked towards developing the CONEXO system further. It is now important that we build on this milestone and continue that development,“ Marcus Ripsam, Head of in evvo solutions, explains.

GEMÜ Gebr. Müller Apparatebau GmbH & Co. KG
D 74653 Ingelfingen



Systec & Solutions and Nymi announce their collaboration on Nymi's secure authentication solution



Systec & Solutions and Nymi Inc. announced their collaboration on Nymi's solution for secure authentication at MES Process Minds trade show in Berlin, Germany. The joint solution includes Systec & Solutions hardware that works seamlessly with Nymi Enterprise Edition authentication solution including the Nymi Band and the Nymi software.



(Picture: Systec & Solutions GmbH)

Systec & Solutions demonstrated this solution at the MES Process Minds show that took place on September 24-25, 2018. Visitors to the Systec & Solutions booth experienced first-hand easy, secure and fast user-authentication using the Nymi Band with Systec & Solutions hardware including an NFC Reader in a hardened case designed for cleanroom environments.

Nymi Enterprise Edition replaces cumbersome and time-consuming username and password entry with a simple tap to an NFC reader integrated in a glass keyboard or the housing of an HMI system. User authentication with Nymi Enterprise Edition and Systec & Solutions hardware takes place in seconds, reducing incorrect entries and leading to significant time savings.



Systec & Solutions GmbH
Emmy-Noether-Straße 17
D 76131 Karlsruhe
Telefon: +49 721 6634 400
Telefax: +49 721 6634 444
E-Mail: talk@systec-solutions.com
Internet: <http://www.systec-solutions.com>

Pfeiffer Vacuum presents new two-stage rotary vane pump Pascal 2021 HW

- Highest vapor capacity in its class
- Ideal for working with aggressive gases
- Flexible and adaptable

With the new Pascal 2021 HW, Pfeiffer Vacuum presents the two-stage rotary vane pump with the highest vapor capacity in its

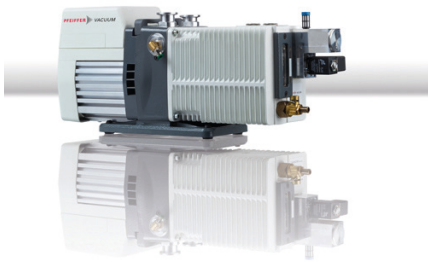

New two-stage rotary vane pump Pascal 2021 HW

class. It is optimally suited for all applications where water vapor is expected, such as low temperature sterilization and drying. An optimized design and gas ballast system allows to pump large volumes of vapor without condensation inside the pump. This prevents accumulation of fluid that would adversely affect the service life of the pump and the oil.

Thanks to the materials used, the Pascal 2021 HW also resists aggressive chemicals such as hydrogen peroxide. The pump is ready to deliver vapor in just a few minutes due to a customized temperature management. It has a safety device that impedes

the ingress of water into functional sections if the steam capacity is inadvertently exceeded.

With accessories such as oil mist filter and inlet traps, the pump can be ideally adapted to most processes. Thanks to its compactness, the Pascal 2021 HW is also ideal for installation into equipment. An oil drain valve simplifies the maintenance in confined spaces. The single-phase universal motor allows for operation almost everywhere in the world.

The proven service concept of the Pascal series makes maintenance predictable and ensures a constantly high availability. The maintenance intervals can be extended by using different operating fluids.

Pfeiffer Vacuum GmbH
D 35614 Asslar

3-in-1 Sensor for CO₂, Humidity and Temperature



The EE850 combines CO₂, humidity and temperature measurement in a single device. The sensor is optimized for building automation and process control.

The duct mount EE850 from E+E Elektronik measures CO₂ concentration up to 10000 ppm (1%), as well as relative humidity (RH) and temperature (T). It is ideal for demand controlled ventilation, building automation and also for climate and process control. The 3-in-1 sensor features a dew point temperature (Td) and a passive temperature output.

Long-Term Stable CO₂ Measurement

The EE850 incorporates the E+E dual wavelength NDIR CO₂ sensor, which is highly insensitive to pollution. The CO₂ auto calibration ensures excellent long-term stability, while the temperature compensation leads to high measurement accuracy over the entire working range from -20 to 60 °C (-4...140 °F). The CO₂ sensing cell is

located in the innovative device enclosure and thus very well protected.

Outstanding RH Measurement Performance

The combined RH/T sensing element is placed inside the probe. The E+E proprietary coating protects the sensing element from dust and corrosion, which leads to accurate measurement even in harsh environment. It also improves the long-term stability by preventing stray impedances caused by deposits on the active sensor surface.

Easy Mounting

External mounting holes allow for mounting the transmitter with closed cover. This saves time and protects the electronics from construction site pollution. Alternatively, the device can be installed with the mounting flange included in the scope of supply.



EE850 duct mount transmitter for CO₂, humidity, temperature (Photo: E+E Elektronik GmbH)

Analogue Outputs and Passive T Output

The CO₂, RH, T and Td measured data is available on the analogue outputs. Additionally, the EE850 features a passive T output. Configuration and adjustment can be easily performed with an optional adapter and the free EE-PCS configuration software.



E+E Elektronik GmbH
Langwiesen 7
A 4209 Engerwitzdorf
Telefon: +43 7235 605 0
Telefax: +43 7235 6058
E-Mail: info@epluse.at
Internet: http://www.epluse.com

Gerresheimer to expand its services to include irradiation of primary packaging

Gerresheimer is expanding its range of services to include surface finishing of plastic packaging for ophthalmology and rhinology products with irradiation. As part of this move, the company is drawing on partnerships with selected certified partners.

“We want to make life easier for our customers when it comes to procuring their dropper bottles and, by treating our products with gamma radiation, we are adding in an important work step before filling,” says Niels Düring, Global Executive Vice President Plastic Packaging. “To help us in this, we are relying on selected, recognized, and certified partners.” The chosen partner companies have the requisite certification in accordance with ISO standards 11137, 11737, and 13004.

Benefits

The benefits of this service speak for themselves: Gerresheimer is assuming responsibility for handling this work step from start to finish, including transport to the irradiation company, monitoring and inspecting its work, and delivering to the location specified by the customer. The inspection processes also involve physically and chemically testing the product characteristics after irradiation. Gerresheimer regulates the validation and revalidation of the entire process, helping to reduce costs for the customer.

Cleanroom production

Gerresheimer’s range of ophthalmology and rhinology products encompasses bottles and dropper inserts made from low-density polyethylene (LDPE) with pump systems to match. Irradiation also ensures the products are germ-free. As a specialist in plastic packaging for the pharmaceutical industry, Gerresheimer offers a wide range of innovative packaging solutions for solid, liquid, and ophthalmological products. All of the company’s primary packaging for the pharmaceutical industry is produced in ISO class 7 and class 8 cleanrooms at its plants in Vaerloese (Denmark) and Bolesławiec (Poland).



Gerresheimer is expanding its range of services to include surface finishing of plastic packaging for ophthalmology and rhinology products with irradiation.

Low germ level thanks to ISO-standard irradiation

The population of viable microorganisms on the surface of a product and/or packaging is called the bioburden. The bioburden is determined in accordance with ISO 11737. Raw materials, components, packaging, and medical products are all investigated in order to gather information about the germ composition and level of germ contamination before treatment. A stable bioburden guarantees a successful irradiation process.

Gerresheimer AG
D 40468 Düsseldorf

cleanroom
online

**CLEANROOM
ONLINE**
FOR A CLEAR
VIEW IN THE
CLEAN ROOM

www.cleanroom-online.com

DeburringEXPO 2019 – Strong Demand for Booth Floor Space



Roughly one year before DeburringEXPO opens its doors for the third time, more than 70 companies have already made firm bookings for their booth floor space. This is a strong indication of growth for the trade fair for deburring technology and precision surface finishing, which will be held in Karlsruhe from the 8th through the 10th of October, 2019. Even greater attention will be focused at the upcoming event on the optimisation of deburring processes for sheet-metal components and additively manufactured parts, as well as parts cleaning after deburring. Added value will be provided by the DeburringEXPO expert forum which is in great demand as a source of knowledge and will offer simultaneously interpreted (German<-> English), highly practical presentations.

DeburringEXPO's exhibition spectrum, which is consistently aligned to deburring, rounding and the production of precision surface finishes, deals with processes which are becoming more and more important in parts manufacturing; despite all of the optimisation measures implemented prior to work-piece processing, residues remain which have to be removed for high quality downstream processes, and in order to assure flawless functioning.

After only two events, the trade fair for deburring technologies and precision surface finishing has already established itself as an international information and procurement platform in this area. This is not only confirmed by the visitors' high levels of decision-making authority, 94% of whom are involved in company decision-making processes, but rather by the exhibitors' experience at the trade fair as well: "We were able to establish contact with numerous tier 2 and 3 companies and smaller businesses from the automotive and aviation industries at DeburringEXPO, as well as from the fields of hydraulics and pneumatics, with whom we weren't previously familiar – not only with companies from Germany, but from many other countries as well such as Italy, France, Belgium, Sweden, Denmark, the USA, India and Brazil. Participation at the trade fair has paid off for us and we'll be back again in two years," reports Keisuke Kaga, Head of Europe Sales at Sugino Machine Limited from Japan.

Numerous other exhibitors at the last trade fair for deburring technology and precision surface finishing arrived at this conclusion as well, and have thus already made firm bookings for their booth floor space at DeburringEXPO 2019. "Thanks to a high exhibitor return rate, frequently associated with increased booth size, as well as new exhibiting companies who have already decided in favour of participating at the upcoming event, the exhibitor list al-



ready included more than 70 companies in mid-October 2018," says Hartmut Herdin, managing director of trade fair promoters fairXperts GmbH & Co. KG. These currently registered exhibitors will occupy nearly 70% of all exhibition floor space rented out in 2017, which is a good indication that exhibition offerings will once again be significantly increased.

A Single Trade Fair for All Materials and All Industry Sectors

As a technology platform for deburring, rounding and the production of precision surface finishes, DeburringEXPO provides a representative overview of the relevant systems, processes, tools and equipment, as well as measuring, test and analysis systems. The exhibition portfolio covers processing of workpieces and components made of practically all technical materials and from nearly all industry sectors. "At the upcoming trade fair, even more attention will be focused on the deburring of sheet metal components than at previous events, in particular lasered parts and stampings, flame-cut and fine-blanked parts, as well as additively manufactured workpieces. Furthermore, we'll also place more emphasis on parts cleaning after the deburring process", adds Hartmut Herdin. Further issues covered by the exhibition portfolio include training and technical literature.

Knowledge as Added Value – Bilingual Expert Forum

Offerings presented by the exhibitors will be rounded out by the integrated 3-day expert forum at DeburringEXPO, which has established itself as a highly popular source of knowledge. With simultaneously interpreted (German <-> English) presentations, it provides visitors with the opportunity of expanding their knowledge in the fields of deburring and rounding, as well as the production of precision surface finishes. Beyond this, examples based on actual practice and benchmark solutions provide ideas and stimulation for the optimisation of processes at one's own company.



(Image source: DeburringEXPO)

fairXperts GmbH & Co. KG D 72639 Neuffen



New: LABVOLUTION AWARD to honor outstanding advances in lab technology



A new competition is being launched in connection with LABVOLUTION. As of the 2019 staging of LABVOLUTION, the LABVOLUTION AWARD will be given in recognition of real-world solutions implemented by lab operators to optimize their work. During LABVOLUTION (21-23 May 2019), high-caliber seminar and consultancy prizes worth a total of over €10,000 will be presented to the lucky winners.

There is no shortage of new initiatives, ideas and projects aimed at making laboratories run more smoothly. Keeping lab samples cool in storage while saving as much energy as possible, finding the best cleaning solution for maintaining the cleanliness of laboratory glassware, devising more efficient ways of doing repeat sample testing, making processes more productive; or designing interfaces that extract new knowledge from large masses of data – these are just a few examples of the brilliant work being done. LABVOLUTION, Europe's premier trade fair for laboratory technology, will for the first time next year award prizes for examples of best practice. The newly created LABVOLUTION AWARD is aimed specifically at users from the laboratory sector, i.e. laboratories, research groups, or deserving individuals. The tagline „Excellence in Lab Optimization“ spells it out very clearly: it's all about outstanding improvements that deliver significant benefits for laboratory work and processes.

„The LABVOLUTION AWARD is not just about the implementation of excellent solutions,“ says Bernd Heinold, project manager for LABVOLUTION at Deutsche Messe. „It's also about identifying solutions with a proven track record of success. So we are creating a platform here for pioneering projects, and also ensuring that

knowledge of best practice is more widely shared.“ The entry requirements have been deliberately left very open. So prizes can be awarded for processes, procedures and methods, or for technologies, software, design, or management techniques. One important requirement is that any relevant improvement should be fully verifiable. And the concept of „improvement“ is itself open to wide interpretation: it may be measured in terms of productivity gains, cost savings, speed, reliability, safety, material usage, energy efficiency, or indeed motivation or employee satisfaction.

Entries for the LABVOLUTION AWARD will be accepted as from the formal announcement of the competition in October of 2018. An independent jury of experts will select three finalists from all the entries submitted. The first, second and third placements will be announced during LABVOLUTION, which runs from 23 to 25 May 2019 in Hannover, Germany. The winners will receive – depending on their specific needs – courses and consultancy services provided by Geniu to the value of €10,000 (first place), €2,500 (second place) and €1,000 (third place). Geniu, a company that offers innovative consultancy services and further training for laboratories, is a sponsoring partner of the LABVOLUTION AWARD.

In order to select the winners, the jury will decide how the entries measure up against the criteria „innovative solution“, „implementation“, and „added value“. Whether an entry rates as an „innovative solution“ depends, for example, on how new or unique it is, and to what extent it increases and improves functionality compared with the previous situation. A further consideration is how simple, reliable and user-friendly the new solution is. How well an entry performs in terms of „implementation“ depends on how effective it is, how quickly it was able to be implemented, and how great the hurdles were that had to be overcome, both internally and externally. As far as „added value“ is concerned, here it is a matter of how extensive the lab optimization gains were, how lasting they are in effect, and to what extent the gains can be explicitly qualified and quantified.

LABVOLUTION showcases all aspects of laboratory work. As Europe's flagship trade fair for innovative lab equipment and laboratory workflow optimization, it covers the full range of lab equipment, lab infrastructure, and analytics for users in the chemical and pharmaceutical industries, life sciences, biotechnology, environmental protection, food and medicine, as well as routine analytics, quality control, and R&D. Thanks to Hannover's central location, LABVOLUTION exhibitors can easily reach lab professionals from North, East and West Germany, the Benelux countries, France, the UK, Ireland, Scandinavia, Poland and parts of Eastern Europe. The keynote theme for LABVOLUTION 2019 is the networked laboratory. One of the highlights of the show, and a major visitor attraction, is smartLAB, the special presentation on the intelligent, networked lab of the future.

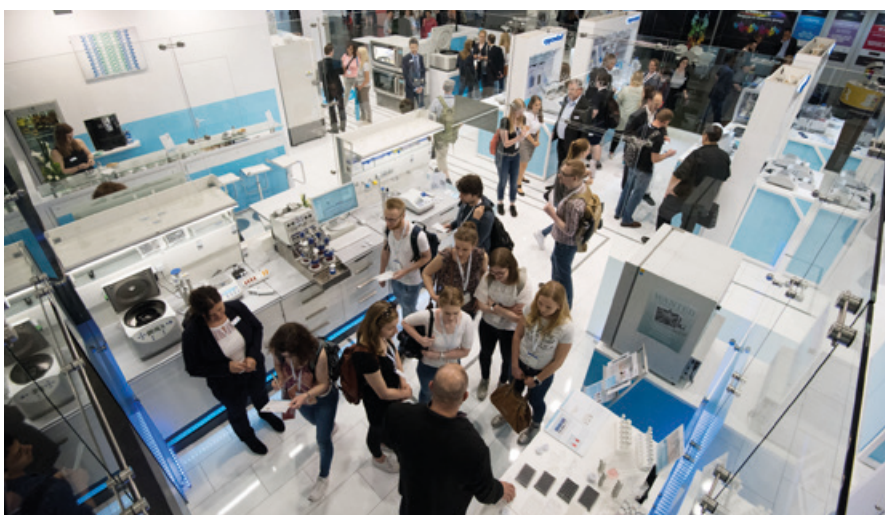

21st - 23rd May 2019: LABVOLUTION, Hannover (D)

Deutsche Messe AG
D 30521 Hannover

Medical technology suppliers offer smart technologies for great leaps in medical care



For some time now, two essential trends have been dominating the field of medical technology and are ensuring short innovation cycles: dematerialization and digitalization. Accordingly, products are increasingly becoming more compact whilst their performance remains the same or is improved, they are increasingly easy to use and as a whole, innovations are driven by software and less by hardware. Intelligent prosthetics capture their surroundings using sensors and by doing so their function is tailored more ideally to the patient. Plasters are able to monitor the wound healing process or act as an early warning system and signal increased risk of an imminent asthma attack. Bracelets functioning as a “mini-hospital on the upper arm” have started appearing on the market. They are able to determine various body parameters such as heart rate, oxygen in the blood, stress levels or sleep rhythms. Even measuring blood pressure durably beat by beat no longer requires an inflatable cuff, as modern optical biosensors are now able to take care of this.

Innovations like these require close cooperation between medical technological manufacturers and their suppliers during development. Often, suppliers are the ones that give the decisive impulses for develop-

ment leaps, and once again, visitors can see this for themselves at COMPAMED in Düsseldorf from November 12 to 15, 2018. With 800 exhibitors from almost 40 countries, COMPAMED is the international leading specialist trade fair for the supplier market for the medical technology industry and takes place alongside the world’s leading medical trade fair MEDICA (5,000 exhibitors). The scope of products, solutions and services presented and addressed at COMPAMED ranges from parts and components such as sensors, chips, wireless modules, energy and data storage to coating technology, packaging solutions and even complete made-to-order production. The list of exciting innovations is a long one, as numerous examples illustrate.

Blue light helps heal chronic wounds

Chronic wounds are notoriously difficult to treat, as they do not follow a typical healing process or healing time frame. The resulting strain is considerable, as over 40 million people are affected every year, causing costs of around 40 million Euros, which must be carried by the health care systems. Blue light is known for its antimicrobial and anti-inflammatory effect during the healing process’s initial phase and in ad-

dition does not damage tissue, in contrast to dangerous UV light. However, there was no evidence of the positive effect of blue light exposure in the later stages of wound healing, which has previously complicated the development of effective solutions for a complete therapy.

Together with six other partners, CSEM has contributed to closing this gap with the EU project MEDILIGHT. This cooperation has proven that exposure to blue light has far more than just an antibacterial effect. The antiproliferative effect has now been clearly proven and shows that blue light prevents the epidermis on the wound surface from closing prematurely in the early healing phase. In addition, the consortium of European research laboratories has proven for the first time that, with a further suitable dose, blue light can efficiently activate vital skin cells, namely keratinocytes and fibroblasts, thus accelerating the final wound healing process. The developed prototype is the ideal solution for an intelligent, mobile system for treating chronic wounds with blue light, for example diabetic ulcers. In addition, the project created the prerequisites for a future commercialisation of devices based on light therapy and to monitor wound healing.

“By discovering and demonstrating the effectiveness of blue light both for antibacterial application as well as for activating vital skin cells, MEDILIGHT allowed us to apply for two patents,” explains Marielle Bouschbacher, project manager at URGO, the participating industry partner and project leader. “MEDILIGHT is also paving the way for further important possible applications such as disinfecting medical instruments and operating environments.”

3D printing rapidly grows in medical technology

3D printing remains a hot topic at COMPAMED. Often termed Additive Manufacturing, the process is growing faster in medical technology than in any other field of application. According to a forecast by the market research company “Markets and Markets”, global 3D printing for medical products is expected to increase from



Medical technology suppliers offer smart technologies for great leaps in medical care

840 million US dollars in 2017 to around 1.9 billion dollars by 2022, a yearly growth rate of 17.5 percent. Key factors for this rapid development are technological progress, an increase in private investments in this sector as well as the increasing application possibilities for the health industry. The growing market is divided into the large segments components, equipment, materials as well as software and services, with the last segment showing the largest growth. Here, the increasing development of progressive software solutions for manufacturing top quality, 3D-printed medical products is the main driving force.

The widely acclaimed seminar “3D fab+print” that took place last year on this topic will be followed up with an all-day conference on this topic held at this year’s COMPAMED 2018 on November 12 (3D fab+print Conference on Additive Manufacturing for medical applications). Among the presenting companies is Evonik, who have been systematically working on improved materials for orthopaedic surgery in their project house Medical Devices since 2014. “We are developing new solutions that help prevent operations or accelerate the healing process,” explains project house manager Balaji Prabhu. In the meantime, Evonik has established first materials on the market, among them a composite that consists of the polylactic acid RESOMER and a synthetic hydroxylapatite filler. Hydroxylapatite is the most common biomineral in the human body. This combination results in mechanical characteristics that are very similar to those of natural bones. RESOMER is completely degraded into carbon dioxide and water in the body, does not cause inflammatory reactions and is completely non-toxic.

RFID chips that can even be sterilised

The entire spectrum of sensors is still a big subject for many providers. The product market “Hightech for Medical Devices”, hosted by the IVAM Association for Microtechnology with 45 international participants, offers a particularly large selection. FEIG ELECTRONIC, for example, presents RFID reader solutions for the healthcare industry to identify medical devices and accessories that depict the consumption of medication and reagents, thus improving patient care and safety. RFID allows the implementation of accurate tracking solutions for medical devices as well as for indi-

vidual processes within medical treatment. This relieves hospitals of numerous administrative and inspection tasks and enables them to use the resources that have been freed for even more intensive patient care. RFID-based inventory systems monitor the current stock of various materials used in hospitals and laboratories: Medication and reagents, blood and plasma bags, surgical instruments, textiles and many more. Additionally, RFID systems ensure accurate patient identification, monitor the respective treatment status and enable warning systems to improve the entire process chain. “RFID registers all relevant information in real time, without employees having to enter data into a computer by hand. This frees up more time for medical and patient care,” confirms Ellie Lee, Manager OR Information Management Services at Sunnybrook Health Sciences Centre in Toronto. FEIG develops and manufactures the entire range of RFID components, not just for medical technological devices, but for optimising hospital processes as well.

As can also be seen at microsensus, RFID technology offers a variety of possible application fields and each solution is subject to their own material and technology requirements. Especially for medical and pharmaceutical applications, there are a large number of guidelines that must be complied with. At COMPAMED, microsensus shows state-of-the-art RFID medical technology solutions and will debut their RFID sensor data logger for seamlessly monitoring temperature during steam sterilisation in autoclaves at +134°C and 3 bar. The company has had the patented mic3 technology since the mid 1990s. This technology realised the world’s smallest RFID transponder with an integrated coil on the chip with a size of approx. 1.5 cubic millimetres. With storage capacities of 64 bit read only to 64 Kbit read/write and temperature resistance of minus 45°C to plus 200°C, the mic3 transponders have sufficient storage capacities and high reliability.

Tailor-made nano coatings

Micro and nano technologies are an important part of COMPAMED. The Dutch company Surfix BV develops and supplies innovative tailor-made nano coatings for the micro and nanotechnology market, based on chemical surface modifications. “Our proprietary surface modification technology can even realize local and selective

surface modifications, which allow complex geometries such as microfluidics, lab-on-a-chip devices and biosensors made of different materials,” explains Dr. Luc Scheres, CEO at Surfix. The coating specialists have extensive expertise in the field of organic, physical and biochemical surface research, which enables them to build a “chemical bridge” between biology and physics. Surfix is involved in the BIOCDx programme, which was started in January 2017 and is financed by the European Union as part of their research and innovation programme. In this project, partners from four different countries work on developing a miniaturised, highly sensitive and reliable Point of Care device (PoC) with a disposable microfluid cassette to monitor cancer biomarkers. The device supports the recognition of primary tumours and metastases with a focus on breast cancer, hormone-resistant prostate cancer and melanomas. As part of the BIOCDx project, Surfix will supply the nano coatings necessary to immobilise the various biomarkers on the surface.

High-ranking participants at the DeviceMed and IVAM forums

In addition to COMPAMED’s exhibition area, two established forums will present the trends in the supplier field of medical technology: In Hall 8b, the COMPAMED SUPPLIERS FORUM (held by the specialist magazine DeviceMed) focuses on the entire medical technology process chain. Among these are mechanical and electronic components as well as innovative materials and all sorts of made-to-order production. This year, particular focal points are Additive Manufacturing (November 12), Cyber Security (November 13), Regulatory Affairs (November 14) and Wearables (November 15). The COMPAMED HIGH-TECH FORUM (Hall 8a) presented by the IVAM Association for Microtechnology places key focus on microsystem technology, nanotechnologies and production technology and process control.

COMPAMED 2018 takes place in Halls 8a and 8b at the Düsseldorf exhibition centre. It is aimed primarily at technical buyers, specialists in research and development as well as packaging, production managers, construction engineers as well as process engineers.

Increasing Effectiveness with 3-D Printing – faster Route to Prototype or Mold Insert



Spang & Brands – COMPAMED, Dusseldorf, November 12 – 15, 2018

As an important expansion of their R&D potential during 2016, when a Technology Center was inaugurated, Spang & Brands GmbH, Friedrichsdorf, Germany, have recently introduced a 3-D printing facility. The aim is to print not only representative samples of medical components, but predominantly to produce mold inserts. With 3-D printed mould inserts injection moulding trials using the original plastics material (dependent on the relative process temperature) can be carried out. Equally, the 3-D printer offers the application of multi-component processes. Simultaneously, different color spectrums and degrees of hardness can be printed. Fully function-

nal medical device samples in the original material are producible in quantities of between 10 and 100 – dependent on material and design – more cost-effectively and significantly faster. With a construction volume of 342 x 342 x 200 mm the PolyJet® 3-D printer can produce components with an accuracy of 16 µm (layer thickness accuracy 200 µm). Original size, characteristic and feel of the printed medical device offer the opportunity to access function testing, thus avoiding production of time consuming and costly aluminium or steel moulds. The use of 3-D printing increases Spang & Brands' effectiveness – once again – in the development of medical devices for the be-

nefit of customers and patients.

'Mindful of high initial costs of medical devices customers expect speedy product development from an all-inclusive provider in order to reach validation*, clinical trials, and introduction to market. Starting with the initial 3-D prototype or 3-D printed trial mould analysis of the prototype status leads to quicker and more flexible optimisation of the individual parts, components and assembly – in respect of value to design and manufacturing, including assembly', adds Friedrich Echterdiek, managing director of Spang & Brands GmbH.

During COMPAMED Spang & Brands will exhibit a variety of different plastics engineering solutions for applications in medical technology, such as syringes, canulas, piercing membranes, implant components, and parts for minimally invasive medicine, plus components for infusions and blood, as well as transition and connection systems. Visitors can see mounted assembled systems and in-house produced complete systems with high-precision geometries and features ready for sale (for instance with precisely defined predetermined breaking points or linking points).

Across the entire value-added chain of a medical devices specialist Spang & Brands demonstrates ground-breaking R&D technology and, supported by a state-of-the-art tooling facility and machine park, i.e. the entire diversity of optimized plastics technological product ranges. Consequently, special plastics compounds, such as TPU, TPE, TPV, resomere materials, and polylactides are used. 'Employing multi-component injection moulding technology our starting point is to embrace increased comfort enhanced with innovative functions and benefits based on the very latest moulding technologies', emphasizes the managing director of Spang & Brands GmbH.



Product impressions – glance into a showcase

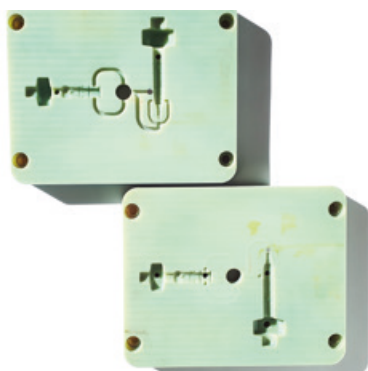

3D-printed mould inserts



Product impressions – glance into a showcase

12th - 15th November 2018: COMPAMED + MEDICA,
Duesseldorf (D)

Spang & Brands GmbH
D 61381 Friedrichsdorf

Raumedic to spotlight silicone processing and wire coating



Compamed 2018

12th - 15th November 2018: COMPAMED, Duesseldorf (D)

With the slogan „All from one source“, the medical technology manufacturer Raumedic will present its wide range of polymer solutions for the medical and pharmaceutical industry from November 12 to 15 at Booth F28 in Hall 8a at Compamed. The company's booth will feature products made of medical-grade silicone and plastic-coated wires, braids and fibers.

Consistent, reproducible solutions made of medical-grade silicone

Silicone is an irreplaceable material in medicine today. Raumedic has been working with the material since the 1950s. Its early products mainly included silicone tubing for extracorporeal circulation (ECC). Today, the company produces the broadest range of silicone components in extrusion and injection-molding processes.

Raumedic specializes in the processing of high-temperature cross-linked silicones. The polymer specialist manufactures a wide



Control and sealing membranes are used in medical pumps. Both sealing lips and control pins are integrated into the injection-molded silicone component.



Foamed silicone round cords are gas permeable and feature outstanding sealing properties.

variety of products out of high-consistency silicone rubber (HCR) and liquid silicone rubber (LSR) as well as from customized formulations. The products include control and sealing membranes for medical pumps, micro-injection molded parts with an extremely low part weight and foamed silicone round cords with exceptional sealing properties.

Raumedic meets the requirements for precise, reproducible silicone solutions by using state-of-the-art extrusion and injection-molding facilities. The tool technology that the company has developed on its own and patented in part ensures that Raumedic can maintain the tightest tolerances during manufacturing. In doing so, the product properties remain consistent even if batch-to-batch variations in raw materials and formulations occur.

VariCoat: The single-step process to coat wires, braids and fibers

Plastic-coated wires, braids and fibers fulfill a wide range of medical purposes. They can be used as guides in minimally-invasive surgery or as signal-transmitting electrodes for neuro-stimulation, for example.

With VariCoat, Raumedic has developed a single-step process that makes it possible to uniformly coat wires, braids and fibers with a large number of high-temperature polymers, technical polymers and standard polymers. Instead of being applied layer by layer, polyamides (PA) and materials like PTFE, FEP, amorphous PEEK and PUR are directly extruded onto the substrate in one single processing step. The possible layer thicknesses range from 0.0004" to 0.039" (0.01 mm to 1.0 mm).

The selection of substrates is virtually unlimited. With the help



Working as medical guidewires, electrodes for pain therapy or light guides - coated wires, braids and fibers are used in many different ways in medicine.

Raumedic to spotlight silicone processing and wire coating

of the VariCoat process, wires and braids from conducting materials like stainless steel, copper and platinum alloys as well as glass fibers and synthetic Kevlar can be wrapped in a layer of polymer. The internal core can have a diameter of 0.001" to 0.059" (0.025 mm to 1.5 mm).

Best production conditions for the best results

At Raumedic, silicone processing and wire coating are done under controlled clean room conditions of ISO Class 7. As a result, contamination by germs and particles is kept extremely low from the very beginning. In addition, the products can be further processed immediately afterward because no subsequent cleaning procedure is required. All incoming raw materials at Raumedic are subjected to a strict incoming-goods inspection. If a customer desires, the

company will also conduct chemical and mechanical pre-shipment inspection.

Raumedic at Medica

Raumedic will also be represented at the Düsseldorf medical trade fair Medica, which will be held at the same time as Compa-med. At Booth G42 in Hall 11, the company division „Clinic“ will present a range of products including the Neurovent measuring catheter, a medical device that can simultaneously measure intracranial pressure, the temperature and oxygen partial pressure inside the brain.

Raumedic AG
D 95233 Helmbrechts

Humidity and Temperature Transmitters HMD60/70

±1.5%RH Transmitters for Demanding HVAC, with a Certificate



The sturdy and reliable duct mounted Vaisala HUMICAP® Humidity Transmitter Series HMD60/70 is designed for monitoring relative humidity in demanding HVAC and light industrial applications. The combination of high accuracy, stability and reliable operation makes this product series an ideal choice for demanding applications.

Two new models are available in this series: HMD62 for measuring humidity and temperature and TMD62 for measuring temperature only. Both the duct-mounted transmitters are robust and reliable, designed for use in demanding HVAC and light industrial applications. The transmitter is resistant to chemicals and dust, and the all-metal body is IP66-rated.

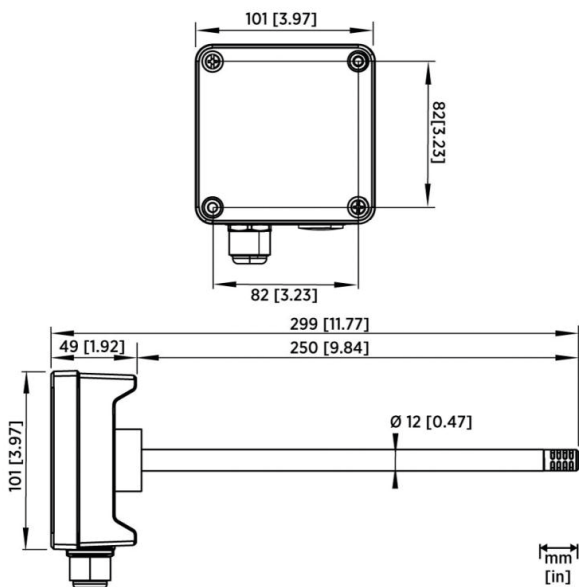

All common humidity parameters are available in the new HMD62: dew point, wet bulb, enthalpy, absolute humidity, mixing ratio. All these parameters can be selected using DIP-switches.

Field adjustment is easy with the high precision trimmers or using the Vaisala HUMICAP® Hand-held Humidity and Temperature Meter HM70. The transmitter is also configurable using the Vaisala Insight PC Software.

The combination of high accuracy, stability and reliable operation makes this product series an ideal choice for museums, cleanrooms and laboratories to mention a few examples. The products come with a traceable calibration certificate.

The new HMD62 for 4 ... 20 mA model replaces the HMD60U and HMD60Y. The TMD62 replaces the HMD60T. HMD70U/T/Y for 0 ... 10 V are also available.

VAISALA



Vaisala GmbH
Adenauerallee 15
D 53111 Bonn
Telefon: +49 228 249710
Telefax: +49 228 2497111
E-Mail: vertrieb@vaisala.com
Internet: <http://www.vaisala.com>

Activating surfaces with flexible and compact plasma sources



At SEMICON Europa FBH will present a compact atmospheric plasma source in operation and further developments based on III-V electronics.

At the SEMICON Europa trade fair in Munich, the Ferdinand-Braun-Institut (FBH) will show-case new developments at the joint stand of »Research Fab Microelectronics« in hall A4, stand 504 from 13 to 16 November 2018.

Among others, the Berlin-based Leibniz institute will present a compact atmospheric plasma source that is suitable, for example, for the treatment of surfaces and for integration into production or process equipment. Test surfaces will be activated on-site in order to prepare them for printing or coating. The source in the 2.45 GHz ISM band comprises a microwave power oscillator, a resonator for plasma excitation and the control electronics, all integrated in a compact housing. Supply of the plasma medium (air, oxygen, argon, ...) and the cooling medium is flexible so that the source can be tailored both for manual use (e.g. in medicine) and for application in production or process machines (e.g. printing, coating systems). The plasma source achieves an output power in the plasma of around 20 W, which is sufficient for many applications.

In addition, an all-in-one pulse light source (PLS) will be shown that combines two core competencies of FBH: customized diode lasers for pulse generation combined with optimized high-speed driver electronics. PLS delivers high-precision pulses in the picosecond and nanosecond range with nano-joule energies. Pulse energy, pulse width, pulse spacing and repetition frequencies can be flexibly adapted. The laser system offers freely selectable repetition frequencies from the Hz to the MHz range and pulse peak powers of up to 50 watts. Via computer control, the all-in-one system can be operated in several pulse modes. Moreover, it can be easily integrated into various laser systems.

FBH will also present the demonstrator of a potential-free differential probe head

for measuring high currents. With this measuring adapter for oscilloscopes, differential electrical signals in the frequency range from DC to over 1 GHz can be measured galvanically isolated – even when superimposed by a high common-mode voltage. Another exhibit will be hetero-integrated chips for terahertz applications, which combine the advantages of two technology worlds at chip level: the high output power of indium phosphide with the complexity of silicon technology.

**13th - 16th November 2018: Semicon Europa,
Munich (D)**

Ferdinand-Braun-Institut
D 12489 Berlin



Compact pulse light source delivering flexible pulses in the picosecond and nanosecond range with nanojoule energies. (© FBH/P. Immerz)

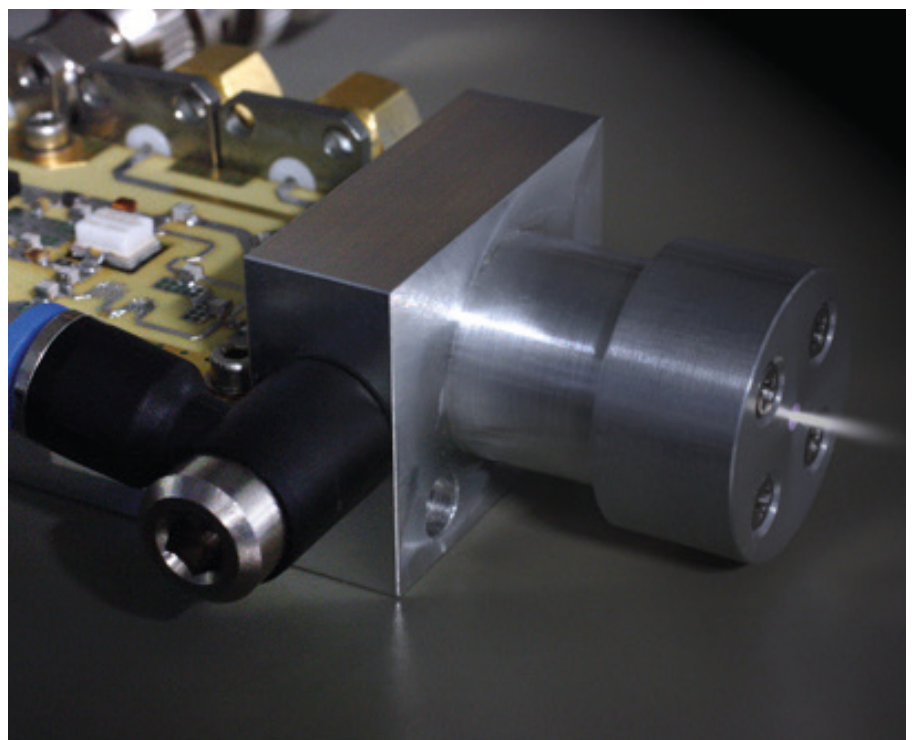

Compact, atmospheric plasma source in the 2.45 GHz ISM band, suited e.g. for surface activation or medical applications. (© FBH/D. Wolf)



ILMAC LAUSANNE – un «must» à nouveau pour le secteur des sciences de la vie de la Suisse francophone



La deuxième édition d'ILMAC LAUSANNE s'est achevée le jeudi 4 octobre 2018. Les chiffres de fréquentation sont très réjouissants et sont au-dessus de nos attentes – près de 1500 visiteurs professionnels ont profité de l'opportunité pour s'informer des dernières tendances et innovations des secteurs de la chimie, de la pharmacie et de la biotechnologie. Plus de 150 exposants ont présenté leurs nouveaux produits dans la Halle 7 de l'Expo Beaulieu. La zone de networking ouverte et animée a complété le format.

La deuxième édition d'ILMAC LAUSANNE a, les 3 et 4 octobre 2018, montré l'importance du marché de Suisse francophone pour le secteur des sciences de la vie. La réaction très positive des exposants est également confirmée par les deux nouveaux exposants Chemengineering Technology AG et Andrew Alliance. «Pour Chemengineering, ILMAC LAUSANNE est l'occasion idéale de renforcer sa croissance en Suisse romande», déclare Marc Bürgi, responsable des ventes chez Chemengineering Technology AG. Sophie Lintermanns, responsable des ventes chez Andrew Alliance, affirme également: «Une formidable organisation et plusieurs visiteurs – nous sommes satisfaits.» Pour ILMAC 2019 à Bâle, les jalons sont déjà posés «Nous nous réjouissons de réitérer en 2019 ce succès à Bâle», poursuit Bürgi.

Un complément parfait

ILMAC LAUSANNE est un élargissement optimal d'ILMAC qui aura lieu du 24 au 27 septembre 2019 à Bâle. L'élément central de la plate-forme est la présentation des produits dans la zone d'exposition qui est conçue comme une superstructure avec des stands systèmes. La zone de networking ouverte est le cœur de la manifestation et sert à l'échange mutuel d'opinions et d'idées.

Des partenaires forts et des thèmes actuels

Le Forum d'ILMAC LAUSANNE s'est déroulé dans les locaux sponsorisés par Riedo. Les partenaires Société Suisse de Chimie, BioAlps et Swiss Biotech Association ont fourni à nouveau les contenus de qualité. Le mercredi, l'accent a été mis sur le thème Process Analytical Technology (PAT). Les défis de l'industrie des sciences de la vie en général ont été abordés le jeudi.

04.10. - 05.10.2020: ILMAC LAUSANNE, Lausanne (CH)

ILMAC

MCH Messe Schweiz (Basel) AG
Messe Basel, Halle 1
CH 4005 Basel
Telefon: +41 58 206 31 06
E-Mail: andrea.voegtli@ilmc.ch
Internet: <http://www.ilmac.ch>

Plastics Processing in Digitalisation Mode



Everyone who's anyone in the field of plastics processing came together at the once again fully booked out Fakuma international trade fair for plastics processing on Lake Constance where Germany, Austria and Switzerland meet for the 26th time from the 16th through the 20th of October. The international exhibitors, as well as private trade fair promoters P. E. Schall GmbH & Co KG, were pleased once more this year with the great demand for this pioneering event in the field of plastics technology: 1933 market and technology leaders from 40 countries presented their companies to 47,650 expert visitors from all over the world.

Global Plastics Industry Does More than Just Adapt to Market Requirements

The proactive technology transformation appears to be succeeding in the field of plastics processing: New materials, more efficient manufacturing processes, 3D and 4D printing alternatives, digitalised and automated production solutions, reduced energy consumption for machines and systems – these are just a few of the regulating screws that need to be tweaked by today's plastics processors. The issue of sustainability, including aspects such as plastics recycling, material savings and biomaterials,

was the subject of more discussion than ever before at this year's Fakuma, because the demands of plastics users such as the automotive industry and the consumer goods and packaging manufacturers are becoming more and more complex. Fakuma 2018 very impressively verified the fact that the plastics industry is up to the challenge, and that it has the most up-to-date tools at its disposal in every regard, in order to work economically with efficient use of materials and resources.

The production of affordable, and at the same time rugged lightweight design structures was presented at the event to just as great an extent as a broad-based portfolio of new materials. New machines, adapted tooling, integrated quality assurance, controllable hydraulic and to an ever greater extent electric drives, and last but not least networkable and thus communicative controllers complete with software – the plastics industry is becoming more and more digital, which is not least of all made apparent by great demand for Industry 4.0-capable equipment and systems.

Fakuma as Popular as Ever

The compact Friedrichshafen Exhibition Centre on Lake Constance was once again fully booked out. Manufacturers

and distributors from outside of Germany now account for more than 42% of the total number. Internationalism has been growing for years. Not least of all the publicity surrounding 3D/4D printing technology and additive manufacturing is causing more and more new and established suppliers from all over the world to appear on the scene, who supplement the portfolio with highly interesting solutions at Fakuma as a globally leading trade fair for plastics processing.

With 47,650 expert visitors from 126 countries, Fakuma plays an important role amongst the experts. The exhibitors all agree: The visitors demonstrate high levels of expertise and the technical discussions are of "high-quality". Consequently, the exhibiting companies were more than satisfied and their comments were entirely positive. Clear-cut positioning as a trade fair for plastics processing – and not as a multi-technology event for plastics issues – makes an essential contribution to Fakuma's excellent reputation as a technical industry meet. It's strictly practice-oriented alignment to the process sequence for plastics processing is a further important success factor for the industry event.

Knowledge and Technology Transfer in Theory and in Practice

Economic growth of the plastics processing industry is only being impeded by the lack of qualified personnel. As a result, expert meeting places like Fakuma are being used to an ever greater extent for recruiting purposes. The objectively oriented supplementary program is an ideal opportunity for technical further training, and at the same time for meeting interesting people. This year's series of events with 69 technical presentations was the ideal setting for expert visitors and exhibiting companies to gather comprehensive information about a great variety of issues.

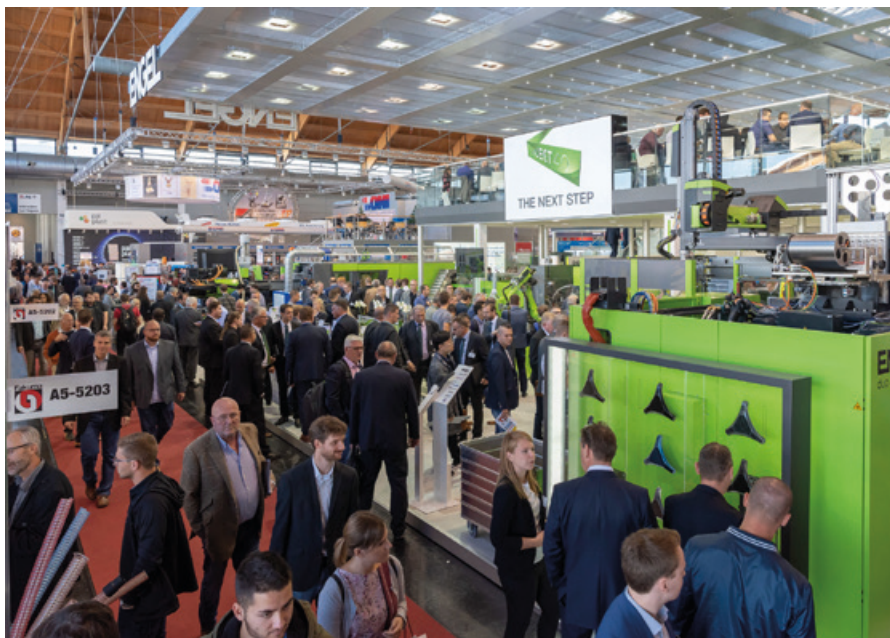

13th - 17th October 2020: FAKUMA 2020;
Friedrichshafen (D)

Mobile operating stations for cleanrooms – The 10 advantages they offer



On a support arm, as a laboratory workstation or flush-mounted in a cleanroom wall. There are any number of mounting options for HMI systems. Not so many people are as yet familiar with mobile operating stations, in other words HMI systems that stand on roller-mounted bases and, equipped with a battery and WLAN, can be moved to wherever they are needed in the cleanroom. Our article explains the advantages to be gained from mobile operating stations such as our TROLLEY systems both for existing cleanrooms and for new premises.

1. No structural work is required for mobile cleanroom operating stations

With mobile operating stations, you can use an HMI system without having to make any structural changes to your cleanroom. This is particularly useful for applications in existing buildings, and obviates the need for expensive construction and conversion work.



2. No effect on cleanroom status and no disruption to production

As there is no need for openings or holes, which would mean a permanent modification of your cleanroom wall, you do not risk losing your cleanroom status when installing, replacing or repairing the operating stations. There is thus no disruption to your production processes.

3. Flexibility makes the best possible use of hardware in cleanrooms

A single mobile operating station can be employed at different working locations and so take the place of multiple fixed HMI systems. Integrated WLAN and a powerful battery in the base provide maximum flexibility. Which means the unit is ready for operation wherever it is needed.

4. The operating stations are designed for simple and efficient cleaning

Fully enclosed in stainless steel, without any beads or edges, mobile operating stations are easy, quick and convenient to clean. Being mobile, there are no hidden corners behind the units. Protection class IP 65 makes them suitable for wiping and spraying with all standard disinfectants.

5. Ergonomically designed cleanroom workstation

Thanks to a hinged keyboard and optional height adjustment, the mobile operating station can be ideally adapted to suit different body heights. Non-reflecting displays provide a perfect view from any angle without having to change posture.

6. Save money and resources by extending battery service life

Cloud-based battery monitoring makes it easy to keep a watch on battery status and quality. Atypical operating statuses are noticed immediately and can be rectified before failure occurs. It also helps your workers to use the batteries correctly, and ensures cost-efficient, resource-preserving and ecological operation.

7. Mobile operating stations are instantly ready for use

Plug-and-Work – Our mobile operating stations are supplied ready for plug-in. There is no need for costly, time-consuming installation work. The workstation is immediately ready for operation. With certain TROLLEY solutions, a printer and scanner are already integrated. And it is also no problem to connect up scanners and printers of other makes via integrated WLAN and Bluetooth interfaces.



Mobile operating stations for cleanrooms – The 10 advantages they offer



8. No cross-contamination with wireless operating stations

To avoid cable-induced cross-contamination we can offer a version of the TROLLEY with inductive battery charging system that does not require any cables whatsoever. The inductive function allows charging even while the system is in operation. So there is no need to interrupt work.

9. A solution to suit every situation

Whatever you are looking for - a powerful battery, a particularly compact unit, a dual screen solution, or an all-in-one package with space for a label printer - we can supply a wide range of mobile TROLLEY system versions to suit your requirements.

10. Immediate and long-term cost savings through the use of mobile systems

All the advantages mentioned above add up to considerable cost savings. Not just by cutting out the expense of installation and reducing the number of HMI systems required. But also by upholding the cleanroom status, avoiding production stoppages and ensuring particularly efficient cleaning.



Systec & Solutions GmbH
Emmy-Noether-Straße 17
D 76131 Karlsruhe
Telefon: +49 721 6634 400
Telefax: +49 721 6634 444
E-Mail: talk@systec-solutions.com
Internet: <http://www.systec-solutions.com>

New compact welding head

Welding head MW 34: compact and productive

The users of orbital welding equipment know the range of closed welding heads from Polysoude type MW for high productivity applications without filler wire, combining a compact and ergonomic design with high duty cycle.

In order to respond to market needs of the food and pharmaceutical industry, chemical production lines and many other applications where ultra-compact welding heads are required, Polysoude has developed the MW 34 with reduced size and new technological improvements.

The MW 34 comes in two versions. Ver-

sion 2T is the best known and most widely used. It has two sets of inserts. Each set is mounted in the clamps, assuring that the two parts to be assembled are held on both sides of the weld joint. The 1T version allows clamping with a single set of inserts, but the gas shielding around the weld joint is provided by protection flanges. This version is useful for places where restricted space may hinder welding operations.

Its range of use from 6 mm to 34 mm makes the tool excellently suited not only to the pharmaceutical, food and traditional chemical industries, but also to aeronautics, biochemistry and micro-electronics.

These welding heads have been specifically designed in order to meet the requirements of the high purity markets. The MW 34 bridges the gap between the UHP series, mainly designed for welding of micro-fittings, and the MW series, which is mainly for the agro-food, pharmaceutical and chemical industries, among others. The MW 34 offers the size advantage of a UHP 1500 head and the productivity of an MW welding head. It also features the same titanium clamp inserts as the UHP 1500, which have a lifetime guarantee. These clamp inserts adapt to tube dimension tolerance variations while ensuring non-contamination.

The standards and regulations governing the food and beverage sector are subjecting manufacturers to ever more exacting quality demands. For this reason, Polysoude has devoted several years to developing orbital welding solutions using the TIG process. Moreover, this process allows us to fully comply with EHEDG recommendations and U.S. Food and Drug Administration (FDA) standards, and follow their advice.

This process is stable and reliable, with or without a filler wire, and can be used on all types of material. It works with a wide variety of welding heads and Polysoude welding power sources, and covers all pipe sectors. It ensures the quality, consistency, and repeatability that manufacturers demand.

For welding applications in a clean room, Polysoude can complete the installation with its P4-3 power source and its optional remote touchscreen. The operator can therefore select the welding mode, then program and monitor the welds without leaving the room. This considerably limits the risk of contamination.



Closed weld head MW 34

POLYSOUDE S.A.S.
FR 44300 Nantes

Mobile and fast quality control of cleaning and coating baths

- **parts2clean 2018: KRÜSS presents the Bubble Pressure Tensiometer**
 - **BPT Mobile for surface tension based surfactant content monitoring**
- **Mobile solution using an intuitive touch display with integrated graphical evaluation**
- **Avoids laborious cleaning and supports quality managers in the design of the monitoring process**

KRÜSS presented a novel solution for quality control of industrial baths that contain cleaning or wetting agents at parts2clean in Stuttgart (Germany) from October 23 to 25, 2018. The new Bubble Pressure Tensiometer – BPT Mobile is an instrument for determining the surfactant content by means of the dynamic surface tension (SFT) of a solution. Working independently from a computer or the power grid and providing results within a few seconds, it is particularly suitable for regular quality checks.

Whether an industrial bath obtains the required cleaning or wetting effect depends on the concentration of free surfactant, which decreases over time due to contamination of the bath or adsorption at the workpiece. The dynamic SFT reacts particularly sensitively to changes of the surfactant concentration so that bubble pressure measurements with the BPT Mobile quickly and reliably reflect the bath's quality.

Time-saving measurements and ergonomic use

The BPT Mobile is equipped with a color touch display for especially simple operation and ensures that every desired function is accurately triggered thanks to the comfortable size of 5". The display also responds to the touch with lab gloves without any problems. The instrument saves time particularly due to the ad-hoc analysis of the results. Whether the measured value lies within a defined quality range is visible at a glance. Moreover, the tendency of the surfactant content becomes immediately obvious thanks to the automatic graphical representation of the course over any given time period. Thus, predictions can be made about when further dispensing will be required or the bath will have to be renewed instead of having to react quickly when a critical SFT value was reached. Using measurements in the Continuous mode of the

instrument, it is even possible to monitor the change in SFT while dispensing a surfactant.

Error-free quality control using reference values

How the SFT correlates with the concentration and at which surface age the bubble pressure method works in the most sensitive way depends on the kind of surfactant used. The BPT Mobile supports the important preparation step of defining the analysis parameters for the subsequent, quick quality routine. For this purpose, the instrument has a mode for measuring the dynamic SFT as a function of the surface age over a wide range between 10 and 30.000 ms. The parameters determined in this way can also be used for easy-to-create templates in order to reliably measure always under the same conditions – also with optimized parameters for different baths independently from each other.

Technical solutions for precise, simple, and robust measurements

For creating the air bubbles in the course of bubble pressure measurements, the instrument uses disposable capillaries which are inexpensive and easily exchangeable. This feature is particularly advantageous for strongly contaminating samples. Thanks to intelligent control and precise measurement of the pressure, the instrument works independently from the immersion depth to the greatest possible extent and thus also accurately performs when held in one's hand. Deviations when used by different persons are therefore virtually ruled out. Moreover, the temperature for each data point can be documented thanks to the removable temperature sensor.

The internal memory of the grid-independent instrument has room for more



Bubble Pressure Tensiometer – BPT Mobile for quality control of industrial baths containing cleaning or wetting agents.

than two million measurements, which can be tidily sorted into folders. Whenever necessary, the instrument can be connected to a computer, behaving like a mass storage device, to export measurements to Excel with one click in order to carry out customized data analyses. The user interface of the BPT Mobile orients itself towards the familiar control logic of smartphones so that false measurements due to operating errors are practically excluded.

Live presentation and talk at parts2clean

At parts2clean, KRÜSS presented the Bubble Pressure Tensiometer – BPT Mobile in Hall 3 at Stand C12 together with other QC solutions in the areas of surface cleanliness and foam behavior. Moreover, Dr. Thomas Skrivanek of KRÜSS was giving an instructive talk entitled Easy and mobile quality assurance solutions along the process chain of cleaning procedures.



New Humidity and Temperature Transmitter Up to 180 °C

With the new EE23-T5, E+E Elektronik expands their transmitter series for humidity and temperature. The device can be used up to 180 °C (356 °F).

The EE23 industrial transmitters from E+E Elektronik measure relative humidity and temperature and also calculate the dew point and frost point temperature. The new model EE23-T5 is suitable for a temperature range of -40 °C to 180 °C (-40 °F to 356 °F) and thus expands the application range of the proven transmitter series. The high-quality E+E humidity sensor with optional sensor coating ensures most accurate and long-term stable measurements.

Range of Different Models

The EE23 series includes models for wall or duct mount as well as different remote probe versions. This makes the transmitter series particularly versatile. Depending on requirements, the devices are available with a robust IP65 / NEMA 4 rated polycarbonate or metal enclosure.

Installation and Service-Friendly Design

The three parts enclosure design facili-

tates easy installation, service and replacement of the EE23. The enclosure consists of the back cover with the terminals for wiring, the pluggable active part with the electronics and the probe, and the front cover. For service only the active part needs to be replaced, while the back cover with the wiring remains untouched.

Sensor Protection for Use in Harsh Environment

The E+E proprietary coating protects

the sensing elements against corrosive and electrically conductive pollution, which leads to outstanding long-term stability even in harsh environment. There is also a wide choice of filter caps available.

Various Additional Options

The measured data is provided on two current or voltage outputs. An optional relay can be used for alarm and control tasks. A display and an integrated power supply module are further optional features of the EE23 devices.

The user can easily perform a two-point humidity and temperature adjustment. The analogue outputs and the relay output can be freely configured.



EE23 humidity and temperature transmitter with metal enclosure.
(Photo: E+E Elektronik GmbH)



E+E Elektronik GmbH
Langwiesen 7
A 4209 Engerwitzdorf
Telefon: +43 7235 605 0
Telefax: +43 7235 6058
E-Mail: info@epluse.at
Internet: <http://www.epluse.com>

Impressum:

cleanroom online / W.A. Schuster GmbH · Mozartstrasse 45 · D 70180 Stuttgart · Tel. +49 711 9 64 03 50 · Fax +49 711 9 64 03 66
info@reinraum.de · www.cleanroom-online.de · GF Dipl.-Designer Reinhold Schuster · Stgt, HRB 14111 · VAT DE 147811997

Original texts and images

The contributions mentioned by name are the responsibility of the particular author. Reprinting, also of extracts, are permitted only with the approval of the editor and with reference to the source. The publisher does not accept any responsibility for unsolicited manuscripts and illustrations. The publisher is granted the exclusive, spatial, temporal and contentual limited right to freely use the article in unchanged or edited form for all purposes as often as desired or to transfer it to third parties for use. This right of use relates to print and electric media (Internet, databases, data carriers of all kinds).