



LUFT. SONST NICHTS.



Clean room hoist in under flange execution moves 10 t of load

With a lifting capacity of 10 tons, the latest innovation from ALT-MANN is a real novelty for the use in single girder clean room cranes. No other construction in under flange execution has reached this capacity class so far. ALT-MANN sets a new standard with this clean room hoist and further strengthens its leadership through innovation.

The extremely favourable construction height makes the clean room hoist perfectly suited for use in clean rooms with low ceiling height. Small clean rooms also profit from the combination of low C dimension and under flange execution: Due to the additionally achieved approach dimension in all long and cross travel directions, the available space can be optimally used. As the hoist is designed for the use in clean rooms of clean room classes ISO 5 / ISO 6, it is possible to lift loads of more than 10 m, with hoist speeds between 0.05 and 8 m/min. Furthermore, the clean room hoist is prepared as standard

instead of ropes or chains maintenance- and lubricant-free load belts are used which do not cause any contaminations due to wear. The standard features of ALT-MANN clean room cranes are smooth surfaces that are optimized for cleaning, low-wear material combinations on friction surfaces and an execution in completely sealed assemblies. The unobtrusive drive technology specifically developed for clean rooms has also contributed to ALT-MANN's leadership achieved through innovation: low-wear material combinations in the deflection and guide pulleys, integration of belt hoist and drive in enclosed housings as well as decentralized control distinguish the ALT-MANN products from other clean room hoists available on the market, not only from a visual point of view. On the one hand, the lack of visible cables increases safety and on the other hand, the cleaning effort is reduced to a such a level that the clean room hoists can be used in 3-shift operation without any problems.

The new clean room hoist with 10 t lifting capacity has proven successful for a well-known customer: 24 hoists of this type were commissioned with two tandem pairs each, the allowable deviation lying below 1 mm across all axes.

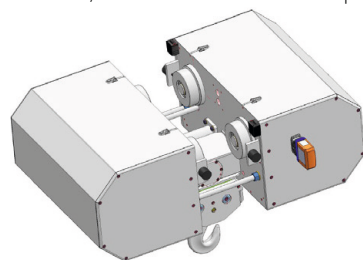

The new clean room hoist in practice: In total, 24 hoists were connected to two tandem pairs each at the customer's site.

for automatic positioning, synchronisation for tandem operation with several hoists and/or cranes as well as for pendulum damping.

Like the electric belt hoist use of stainless steel introduced last year, the new clean room hoist also complies with the ALT-MANN clean room standard. This means that



ALT-MANN GmbH
Oberdieberg 23-25 D 83544 Albaching
Telefon: 08076 / 8879-0 Telefax: 08076 / 8879-20
E-Mail: kontakt@altmann-foerdertechnik.de
Internet: <http://www.altmann-foerdertechnik.de>

IN PREPARATION
CLEANROOM YEARBOOK 2021



December 2020

Dear subscribers,

the Advent season has begun and Christmas is just around the corner. Whether Father Christmas is allowed into our living rooms with or without a mouth-nose cover is still not safe.

Now is the time for reflection, the time to reflect on the past year and the time of confidence with the wishes for the future. For some people it is a stressful time with project and year-end closing, for others is this end of the year rather difficult by loss of sales or fear for the job due to the lockdowns.

I hope that no matter how relaxed or tense you are, you will find the time to read the latest Newsletter. You should take your time, because it became very extensive with many interesting articles.

For example we report about:

- > **Clean room hoist in under flange execution moves 10 t of load**
- > **How does a wipe become a cleanroom wipe?**
- > **International, innovative and interdisciplinary: Cleanzone Digital Edition focused on controlling COVID-19 and on cleanroom solutions for high-tech products**
- > **Fraunhofer IPA presents disinfection robot "DeKonBot"**
- > **A new OSD Customer Center in Waiblingen**
- > ...

Yours sincerely

Reinhold Schuster

How does a wipe become a cleanroom wipe?

Independent assessment of the cleanroom suitability of wipes from the PurWipe® series

Among the common cleanroom consumables that are used on a daily basis in cleanrooms, cleanroom wipes play a leading role in terms of relevance and consumption quantities. When using consumables for critical environments the knowledge of the contamination behavior of these products is of crucial importance. Due to the proximity to the production process or the product itself, specifically the airborne particulate contamination emanating from the consumable product are of concern. Therefore, all cleanroom wipes must be examined and evaluated regarding their cleanroom suitability and thus their particle emission behavior.

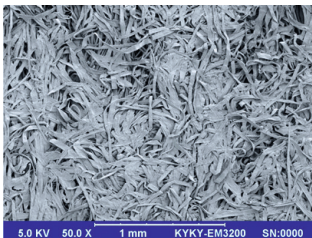

non-woven fabric
Enlargement 50x

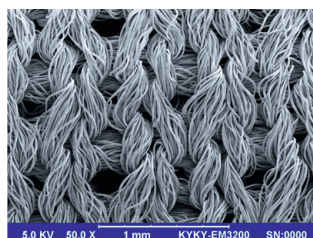

Polyester knitted fabric
Enlargement 50x

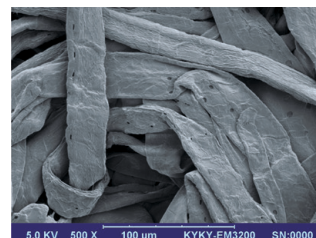

Cellulose fibers
Enlargement 500x

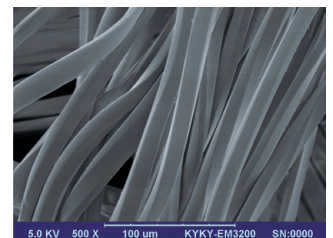

Polyester fibers
Enlargement 500x

But how to translate these regulatory requirements into practical testing and tangible results? In the following, the author will try to make this complex topic easier.

Particle emission behavior – what?

The goal of safe production under “clean conditions” is countered by the release of particles on to surfaces and to the air by cleanroom equipment and consumables such as cleanroom wipes. The cause of

this emission, which needs to be controlled, is on the one hand the wipes material construction and on the other hand the mechanical stress it is exposed to. Even a simple and appropriate use of the wipe on a surface causes abrasion and as a result, particle generation and emission. By the way, this is also the case regardless of the sterility of the wipe. In fact, the usual sterilization by means of gamma radiation can lead to additional stress on the wipe.

To use the wipe properly, it must be folded, soaked with a cleaning agent or disinfectant and finally brought into contact with the

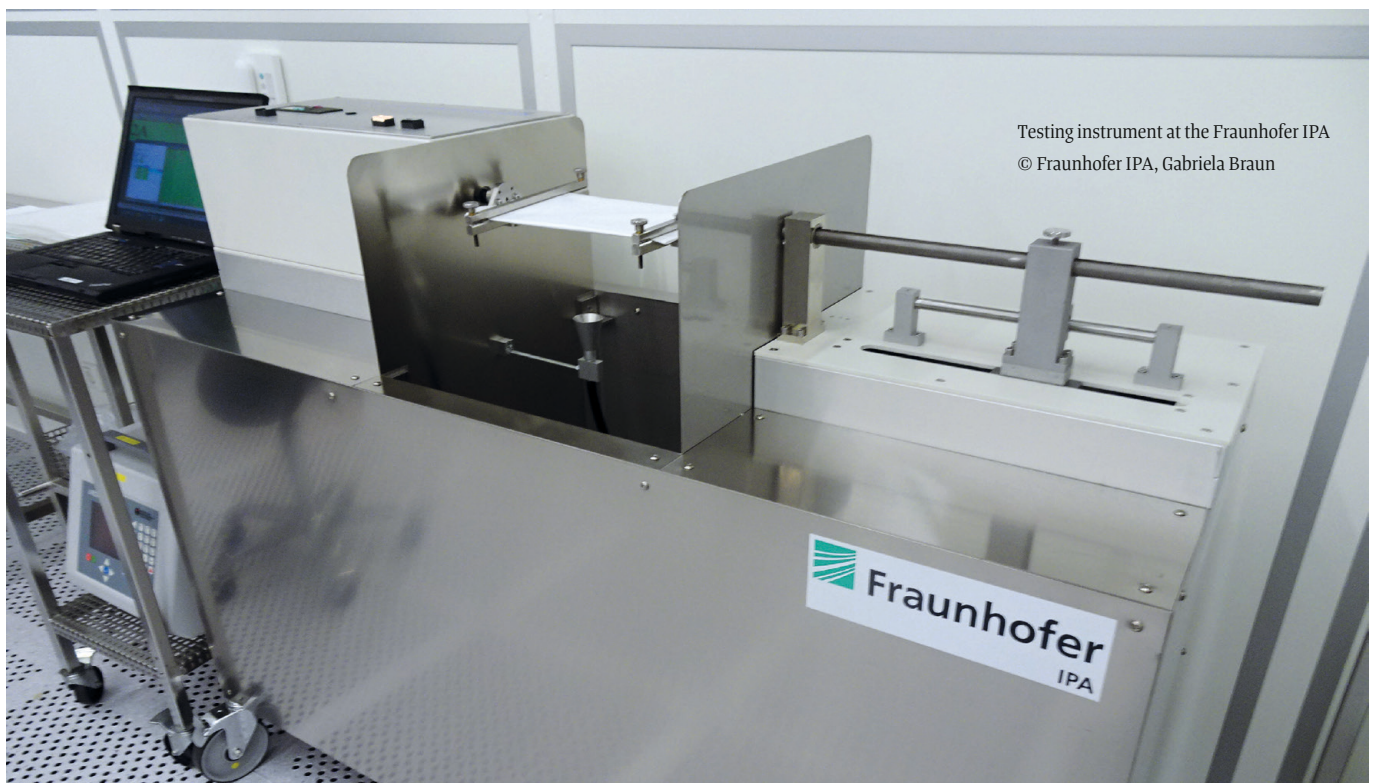

How does a wipe become a cleanroom wipe?

surface to be cleaned. It does not magically attract the particles but has a cleaning effect when the fibers and the woven or nonwoven structure interact with the surface to gather and bind particles. Cleaning efficiency describes how much of the soiling on the surface before cleaning is removed by the wiping process. Wiping therefore inevitably involves friction, which in turn releases particles at a higher or lower level. In conclusion, the design of the wipe must be selected so that it has the lowest possible particle emission and the highest possible cleaning efficiency under the conditions of usage.

Therefore, cleanroom wipes are made of synthetic fibers and are processed in such a way, that they are as chemically resistant and abrasion resistant as possible. When selecting nonwoven wipes, particular attention must be paid to their material composition as well as the bonding and finishing process. Very few commercially available nonwoven wipes are suitable for critical applications under cleanroom conditions.

The following factors (among others) influence the cleanroom suitability of wipes:

- Material selection - Image 1: polyester fibers vs. cellulose fibers under SEM
- Material structure / quality - Image 2: knitted fabric vs. non-woven fabric under microscopy
- Manufacturing process and preparation
- roughness of the surface to be cleaned

Assessment of the PurWipe® wipes at the German Fraunhofer Institute

The „particle problem“ only becomes apparent at a closer look. More specifically, it becomes clear that the problem is not visible, at least not to the naked eye. The enemy “particle” passes the human eye

largely undetected. So how to evaluate? How to make sure my wipe is actually a cleanroom wipe?

Clearly, test instruments and valid testing standards for measurement and qualification must be used. Tests for particle emission of wipes are usually carried out and documented on a batch specific basis by the manufacturer. While this is an important tool in quality assurance, this does not mean that the wipe is specifically assessed as being cleanroom suitable, and certainly not by an independent body. In order to determine whether a wipe is suitable for use in a certain cleanroom class due to its particle emission behavior, an assessment of the suitability for air cleanliness classes according to ISO14644-1 must be carried out.

To evaluate and qualify the wipes of the PurWipe® series, Hydroflex has performed testing at the renowned Fraunhofer IPA, an independent public research institute specialized on cleanroom production environments. The tests were carried out in the competence center for ultra-pure and micro-production in a class 1 cleanroom (according to ISO 14644-1). A special testing instrument based on the specifications of ISO 9073-10 “Analysis of fiber fragments and other particles in the dry state” was used for the measurements. A particle counter with a measuring probe was positioned below the test object, during which it was exposed to a defined mechanical load. The qualification measurements were also carried out according to the new guideline VDI 2083 Part 9.2. The particle measurements were evaluated in accordance with ISO 14644-14.

At the heart of the investigations was the question, to what extent the PurWipe® wipes can be used in clean environments and in which cleanroom classes. To classify the wipes, the measured particle values were statistically analyzed and evaluated with reference to the class limits specified in ISO 14644-1. Of all test samples, the “worst-case”, i.e. the worst result, was used for the classification.

Conclusion: „Suitable“

The independent testing of the wipes at the Fraunhofer IPA Institute confirms: PurWipe® N2, K1, K3 and K4 are suitable for cleanrooms up to ISO class 4.

Due to the high quality standards in the production of the PurWipe® wipes under cleanroom conditions, as well as the development of the wipes specifically for the high requirements in cleanrooms, these wipes enable safe use under clean conditions, while uncontrolled particle emissions and a risk to the cleanroom status are avoided. With the qualification certificate from Fraunhofer IPA and the “Tested Device®” seal for PurWipe® wipes, an independent proof of cleanroom suitability is provided, which is an important part of product qualification.



Hydroflex Group GmbH
Cleanroom Hygiene
Am Weidenhäuser Bahnhof 8
D 35075 Gladenbach
Telefon: 06462.91598-0
Telefax: 06462.91598-20
E-Mail: info@hydroflex-group.com
Internet: http://www.hydroflex-group.com

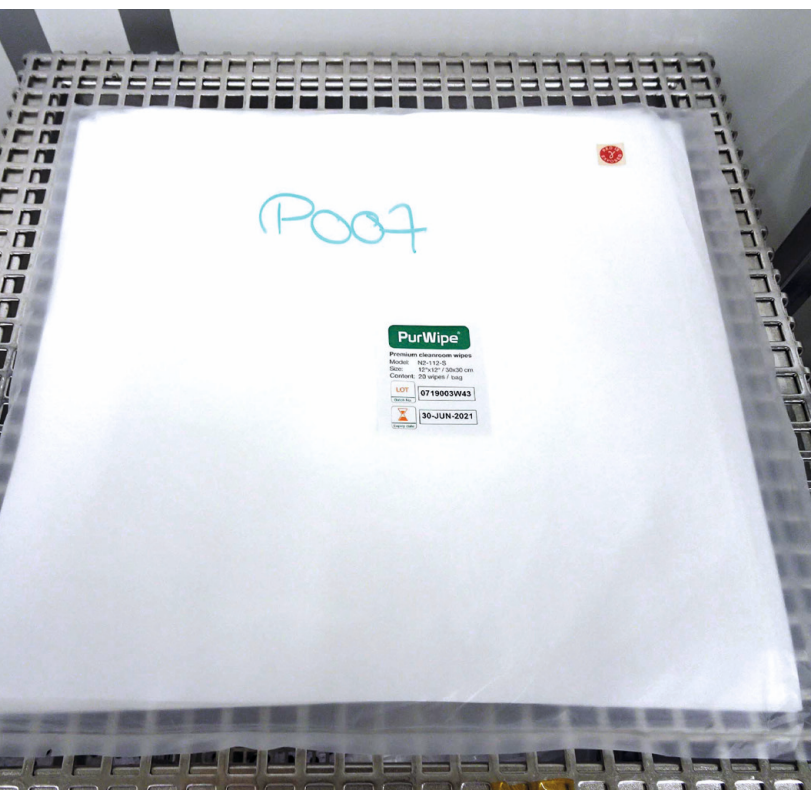

New HMP1 probe for humidity and temperature measurements in high-end facilities

The new HMP1 probe provides the best performance for measurements in critical production and storage facilities as well as in locations such as data centers where measurement accuracy, easy maintenance, and robustness are crucial.

Vaisala, a global leader in weather, environmental, and industrial measurements, has today introduced a new HUMICAP® Humidity and Temperature Probe HMP1. With its top-of-the-line accuracy and sensor purge functionality that ensures excellent stability over time, the HMP1 is an ideal choice for demanding humidity measurements in environments such as pharmaceutical facilities, data centers, clean-rooms, or any other environments that require strict humidity monitoring and control.

The product features the recognized and space-proof HUMICAP® sensor technology, which is known to endure demanding conditions.

The HMP1 complements the Indigo product family, which is a premium solution for multi-parameter measurements with flexible connectivity. The modular product family consists of interchangeable smart probes, transmitters, and Vaisala Insight PC Software, which together create a strong chain of data to ensure energy efficiency, safety, and end-product quality.

Premium solution for wall-mounted humidity and temperature measurements

The probe is compatible with any Vaisala Indigo series transmitter. The possibility to detach the probe from the transmitter allows efficient maintenance and calibration. With the Indigo200 series transmitter the HMP1 probe forms a single wall-mounted unit with no probe cable or probe holder needed. The robust Indigo520 transmitter offers installation flexibility and allows optimal positioning of the probe. It also enables dual-probe installations for extended parameter monitoring or extreme accuracy.

The unique combination of measurement performance, easy maintenance, and the extensive range of additional features in the Indigo transmitter series creates a premium solution for wall-mounted humidity and temperature measurements in demanding applications.

The HMP1 can also be used as a standalone wall-mounted trans-



mitter over Modbus RTU serial bus. Whether the HMP1 is used as a standalone unit or with an Indigo transmitter, it can be connected to the complimentary Vaisala Insight PC Software for easy field calibration, probe configuration, and device analytics.

Software update for the Indigo520 transmitter

In addition to the product launch, Vaisala has also announced a software update for the Indigo520 transmitter that includes temperature compensation. Together with the Indigo-compatible humidity and temperature probe HMP1 and the temperature probe TMP1, it now also delivers accurate and reliable relative humidity data in condensing environments such as test chambers or fuel cells, where traditional instruments fall short.

"We are very excited about the news! The HMP1 and software launch together sum up our ambitions perfectly: Helping our customers across industries to optimize their processes for better results by building on our very strong technology base, and to provide industry's most reliable solutions to measurement challenges in demanding applications," comments Vaisala's Product Manager Jarkko Ruonala.

The Vaisala HUMICAP® HMP1 probe will be available to order in December 2020.



VAISALA

Vaisala GmbH
Adenauerallee 15
D 53111 Bonn
Telefon: +49 228 249710
Telefax: +49 228 2497111
E-Mail: vertrieb@vaisala.com
Internet: <http://www.vaisala.de>

International, innovative and interdisciplinary: Cleanzone Digital Edition focused on controlling COVID-19 and on cleanroom solutions for high-tech products

On 18 and 19 November 2020, the digital networking event Cleanzone Digital Edition brought together cleanroom experts from all over the world. Solutions for combating the COVID-19 pandemic were a hot topic, as were new approaches to the construction of cleanrooms for medical and microtechnology applications. All participants and everyone else who is interested can continue to use the platform until 18 December to make contacts and view the recorded content.

What can we learn from the field of cleanroom technology regarding the ongoing pandemic? Experts got together to discuss this issue, which is important to society as a whole, and shared their knowledge of air purifiers, airlocks and proper cleanroom behaviour and processes. Their conclusion: The cleanroom industry possesses the know-how and expertise to advise governments and society alike. This issue was also reflected in the products and services on offer from exhibitors at Cleanzone Digital Edition, including Ortner Reinraumtechnik, Mann + Hummel and Siemens.

The presentations given by David Lindholm from KeyPlants and Martin Birch from G-CON were greeted with particular interest by the participants at Cleanzone Digital Edition. Both keynote speeches presented new approaches for industrial construction using prefabricated and tested modules that make it possible to build new facilities quickly – something that is especially important for the production of medications and vaccines. The industry is looking ahead to the future, to ensure that they are also well equipped for the time after the coronavirus. Here, experts explored new possibilities for using automation to increase production reliability and safety. Investments in the battery technology that are so important to the energy transition and the requirements for cleanroom production that these entail were also among the highlights at Cleanzone Digital Edition.

Business booster: Being recognised for the Cleanzone Award 2020

Never before have so many companies submitted their innovations for consideration for the Cleanzone Award, and never before have so many products been in the running for this coveted honour: Seven nominees managed to impress the panel with extraordinary approaches that break new ground in terms of sustainability and energy efficiency – or even enjoyment, as with a cleanroom game. The winners – who won the vote by a considerable margin – were Textilforschungsinstitut Thüringen-Vogtland e.V. and Ortner Reinraumtechnik. Their innovation: a sustainable coating for textile surfaces that photo-dynamically inactivates micro-organisms.

Streams + Sessions + Content + Networking = Success

Be it as visitors, exhibitors or speakers – feedback on the digital edition of Cleanzone has been positive from everyone involved. Kerstin Horaczek, Group Show Director Technology at Messe Frankfurt, was delighted with Cleanzone Digital Edition: “In September it became clear to us that any international dialogue this year would have to take place digitally, and we have been putting all our efforts since then into creating an effective networking platform. Naturally we were

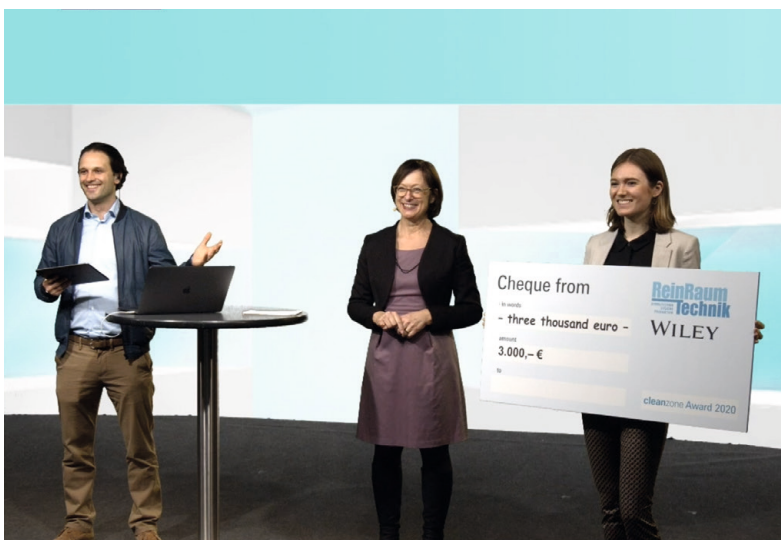

Cleanzone Award: honouring the winners



International, innovative and interdisciplinary

very much looking forward to seeing how the industry would react to our digital format, so we are particularly delighted by the positive reception, the high visitor quality, and the large numbers of business contacts that were made. 'Digital natives' – tomorrow's specialists in the cleanroom industry – were particularly pleased with the event."

Cleanzone's partners, including the German Cleanroom Institute (DRRI) and the International Confederation of Contamination Control Societies (ICCCS), were also involved in putting together the Cleanzone Digital Edition programme. The platform also hosted the presentation of an EU-supported programme for measuring airborne chemical contamination.

And the networking continues: All Cleanzone Digital Edition participants can continue to make use of the platform until 18 December 2020. Here, everyone who is interested can continue to view recorded content and network with business partners. Anyone who was unable to take part in Cleanzone Digital Edition before now can still obtain a ticket free of charge.

Facts and figures: All the key facts and figures for Cleanzone Digital Edition:

- Over 1,500 viewers followed the live streams
- Participants from 46 countries
- International component of visitors: approx. 50 percent
- Approx. 3,000 recommendations – 80 percent of which resulted in mutual interest
- Approx. 40 hours of compelling content (available on demand until 18 December)

The next Cleanzone will take place on 24 and 25 November 2021 in Hall 1.2 on the Frankfurt exhibition grounds.

cleanzone

cleanzone

Messe Frankfurt Exhibition GmbH

Ludwig-Erhard-Anlage 1 D 60327 Frankfurt am Main

Telefon: +49 69 7575 6290 Telefax: +49 69 7575 96290

E-Mail: anja.diete@messefrankfurt.com

Internet: <https://cleanzone.messefrankfurt.com/frankfurt/de.html>

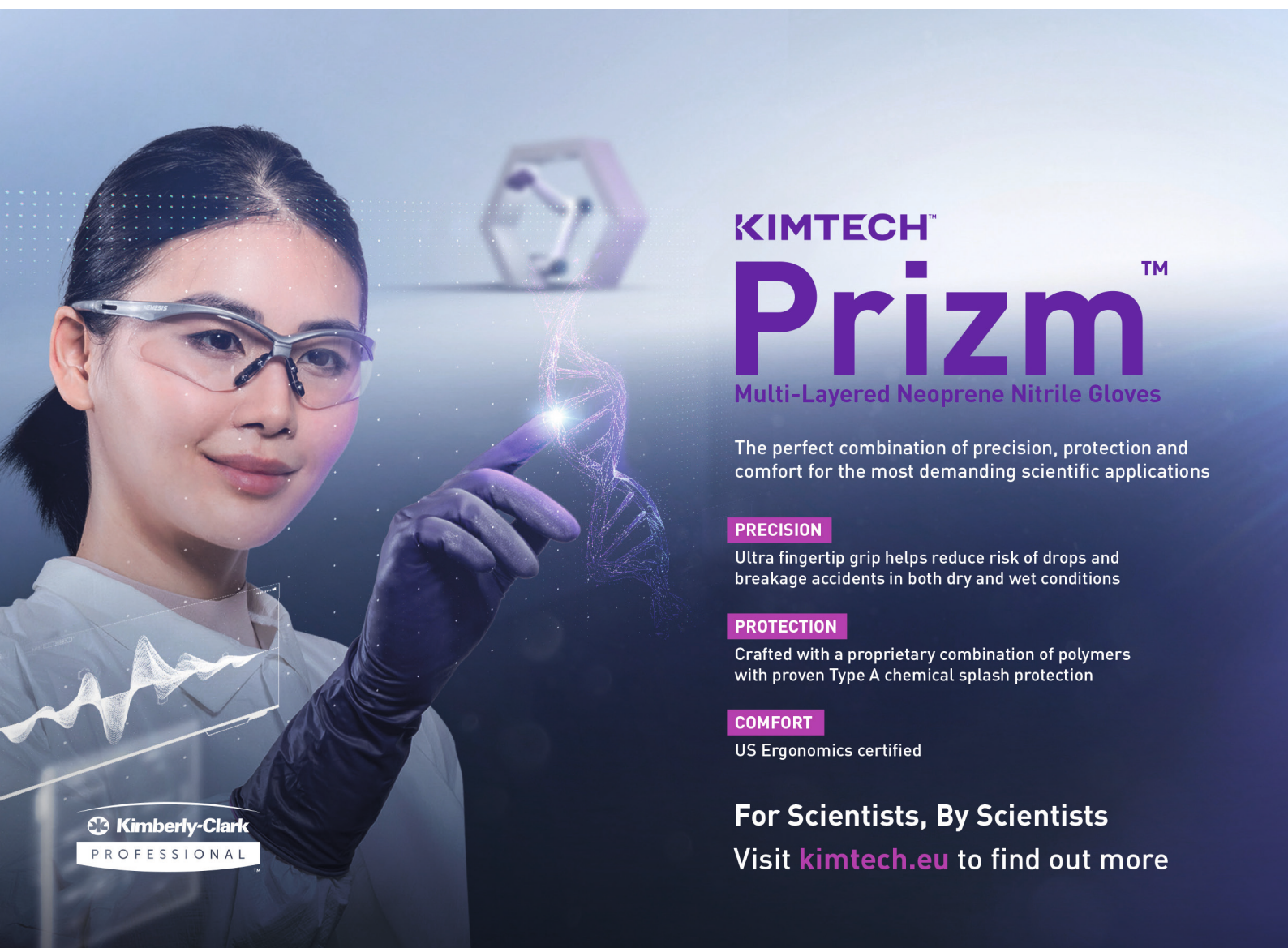

KIMTECH™

Prizm™

Multi-Layered Neoprene Nitrile Gloves

The perfect combination of precision, protection and comfort for the most demanding scientific applications

PRECISION

Ultra fingertip grip helps reduce risk of drops and breakage accidents in both dry and wet conditions

PROTECTION

Crafted with a proprietary combination of polymers with proven Type A chemical splash protection

COMFORT

US Ergonomics certified

For Scientists, By Scientists

Visit kimtech.eu to find out more

Plair and MBV sign a collaboration agreement to develop next-generation solutions for rapid microbiological detection

Plair SA, the Swiss creator, manufacturer, and provider of instruments for real-time bio-aerosol monitoring, and MBV AG, the Swiss global leader in viable air sampling, jointly announce today the start of a strategic partnership to bring to the market new and innovative automated solutions for microbiology monitoring that combine the technology of both companies.

As part of the agreement, NewGen Holding AG, the parent company of MBV, will invest in Plair's share capital to strengthen the collaboration between the experts. Further, Ronny Zingre, CEO and MBV Board Member, will join Plair's Board of Directors.

Plair is a start-up company, a spin-off from the University of Geneva, specialized in the early detection and identification of airborne particles in outdoor environments based on its state-of-the-art laser technology. This technological leadership allows Plair to extend its applications to instantaneous, viable particle monitoring in indoor controlled environments such as cleanrooms.

"We are thrilled to enter this new alliance, which includes both innovative technology and long-standing industry expertise. Our joint forces will help to develop the most advanced and top-notch solutions for industries requiring the highest quality and standards," Dr. Denis Kiselev, CEO of Plair, commented.

MBV is a family-owned industry expert that develops, manufactures, distributes, and services market leader MAS-100® microbial air sampler solutions. The high-quality, innovative instruments are used around the world to monitor areas in which microorganisms can have

a negative impact, for instance in the pharma, cosmetics and food industries, in scientific research and in the manufacture of medical devices. Quoting Ronny Zingre: "Innovation through collaboration: that is what we stand for here at MBV. This new partnership with Plair has the great potential to address developing market needs and permit our customers to efficiently produce compliant products and serve their clients."



LUFT. SONST NICHTS.

MBV AG
Microbiology and Bioanalytic
Industriestrasse 9 CH 8712 Stäfa
Telefon: +41 44 928 30 80
Telefax: +41 44 928 30 89
E-Mail: welcome@mbv.ch
Internet: <http://www.mbv.ch>



Plair SA CEO Denis Kiselev and Co-founder Svetlana Kiseleva



MBV AG CEO Ronny Zingre

Mobile filter unit reduces virus contamination in schools

Filter Fan Unit „WINDfried“ improves air quality in schools and public spaces

The Corona Pandemic still bothers us more than we would like. The local school of our community now had the idea if our high performance filters could not also contribute to the improvement of the air quality in the school. Actually at home in the very controlled world of cleanroom technology, we then designed a filter unit that moves on wheels and can easily be plugged into any household plug to start operation. The filter box has a ULPA 15 filter that filters particles down to $0.12\mu\text{m}$ from the air - the Covid-19 virus has a size of about $0.16\mu\text{m}$. However, the viruses do not occur sporadically anyway, but are bound to droplets in the form of aerosols and can therefore be caught by high-

performance filters. Since the ULPA 15 filters also work very quietly, noise pollution during lessons was not a problem. However, we were actually surprised by the results of the particle measurement that we usually carry out to control the particle concentration in our qualified clean rooms. This time, the measurement was carried out in normally equipped rooms and with up to 23 students during operation. The result was even more pleasing: the viral contamination could be reduced by a factor of 10 by using the filter box. Measurements at other schools confirmed the results and were so positive that we are now offering the filter box, which we named „WINDfried“, to other interested customers.



Schilling Engineering GmbH
Industriestrasse 26
D 79793 Wutöschingen
Telefon: +49 7746 9278971
E-Mail: i.doerffeldt@schillingengineering.de
Internet: <http://www.schillingengineering.de>

Corona pandemic: interplastica and upakovka 2021 in Moscow cancelled

Next date 25 to 28 January 2022

The trade fairs interplastica, International Trade Fair for Plastics and Rubber, and upakovka, No. 1 Trade Fair in Russia for Processing and Packaging, scheduled for 26-29 January 2021 at the AO Expocentre exhibition centre in Krasnaya Presnya in Moscow, have been cancelled and will take place on their next regular dates, 25-28 January 2022. This is Messe Düsseldorf's response to the ongoing pandemic situation and the current tightening of quarantine regulations in Russia.

„The decision was taken by Messe Düsseldorf in close cooperation with Messe Düsseldorf Moscow,“ emphasises Erhard Wienkamp, Managing Director of Messe Düsseldorf, and continues: „Moscow has taken stricter measures to contain the corona pandemic due to the drastic increase in the number of infections. Cultural, educational and other events are prohibited until mid-January. No one can say at the moment what will happen immediately afterwards.“ The current announcement enables all participants of the interplastica and upakovka to react in time, to reschedule and to concentrate on the event date in January 2022.

interplastica is the most important business platform for the Russian plastics and

rubber industry. It offers a representative overview of machinery, raw materials and equipment, such as plastics processing and recycling plants, welding machines, measuring and control technology, raw materials and supplies, as well as plastic and rubber products. interplastica is particularly aimed at representatives of the plastics, chemical and mechanical engineering industries.

As a member of the interpack alliance, upakovka with its offerings for the packaging and related process industries is aimed at the target groups of food, beverages, confectionery and bakery products, pharmaceuticals, cosmetics, non-food and industrial goods.

The international orientation of both trade fairs enables visitors to find out about

innovations from all parts of the world and obtain offers specially tailored to the Russian market.

Messe Düsseldorf Moscow is currently investigating to what extent it can offer interested companies other presentation options for 2021. The next regional trade fair as a live event will be the already firmly established interplastica Kazan, Trade Fair Plastics and Rubber, parallel to the Tatarstan Oil, Gas & Petrochemicals Forum in the Republic of Tatarstan/Russia in September 2021. The exact date will be announced shortly.

Messe Düsseldorf GmbH
D 40001 Düsseldorf

More space for the Small Batch Production of plastics

Gerresheimer is expanding the production area for Small Batch Production of plastics in Wackersdorf

Gerresheimer Regensburg is increasing the capacity of its Small Batch Production in the Technical Competence Center (TCC) Wackersdorf. To this purpose, already existing production area has been converted into clean room space, and a new building with additional clean room and office space has been completed. The company is reacting with the expansion of production space in keeping with the growing number of projects that require smaller numbers of units or for which a smaller number of complete products are already required prior to large batch production for development, approval, and industrialization.

Gerresheimer had already invested a double-digit sum in the millions in the expansion of Small Batch Production in Wackersdorf in 2018. In the context of the plastic and glass competence of the company, 900 square meters of additional area was at that time created for the development and industrialization of glass products like syringes and

carpules.

A double-digit sum in the millions is once again being invested to adapt the capacity of Small Batch Production in the plastics segment to the growing number of projects. Produced here are, for example, patch pumps for administering medication, drug containers for injection without needles, point-of-care

tests, infusion sets for X-ray contrast agents, syringes, and much more. To this purpose, existing production space was converted into a 500 square meter clean room of the ISO-14644-1 classes 8 and 7. This clean room is already in operation. In a second step, an extension building is now being built, which, in addition to 245 square meters of office space, also provides 1,200 square meters of additional clean room area. Up to now, Small Batch Production had a total of 1,800 square meters of production area for the plastics segment in the ISO classes 7 and 8, as well as rooms of the GMP classes C and D for pharmaceutical glass production. Following the conversion, with 2,200 square meters, more than double the clean room area of ISO classes 7 and 8 are available for plastic production. The total production area of Small Batch Production now amounts to 2,900 square meters.

Through the manufacture of medical devices, such as, for example, patch pumps with internally developed micro pumps, in Small Batch Production, Gerresheimer Regensburg opens up a new business area as an Original Equipment Manufacturer (OEM). The classification of the company in the commercial register is therefore being supplemented by the point "Manufacture of medical and dental apparatuses and materials."

The expansion of production capacity in Small Batch Production is required due to the growing number of development projects for pharmaceutical and medical technology products. Prior to batch production, these products are subjected to a protracted development and approval process, for which small numbers of units are often required as samples. Small Batch Production thereby ensures the required product quality, as well as complete batch documentation at the level of subsequent large batch production. The experiences can also be transferred directly to subsequent production on a large scale when establishing large batch production.



From left to right: Holger Heining (Head of Small Batch Production, Gerresheimer Regensburg GmbH, Wackersdorf) and Michael Wiglenda (Global Senior Director Technical Competence Center & Moldmaking, Gerresheimer Regensburg GmbH, Wackersdorf)

Freeformer predestined to medical technology

- Original material: Arburg Plastic Freeforming of medically approved plastic granulates
- Application example: Additive manufacture of absorbable bone implants
- Suitable for clean rooms: Freeformer with stainless steel build chamber

Arburg Plastic Freeforming (APF) with the Freeformer is predestined to highly demanding applications in medical technology. The process works from the same plastic granulates that are used in injection moulding. This makes the open system very economical to use. The Freeformer can also process biocompatible, absorbable, sterilisable, and FDA-approved original materials into functional components as well as be used in clean rooms.

During Formnext Connect 2020, the processing of our partner Evonik's absorbable materials for implants will be presented as an example.

Absorbable implants

The processing of Resomer LR 706 (composite of poly L-lactide-co-D,L-lactide and β -TCP) is an impressive example of the use of the Freeformer. Samaplast can use it to manufacture implants that are inserted directly



The company Samaplast has used a Freeformer 200-3X and APF to process absorbable original materials into bone-like implants. (Photo: Arburg)

into the body after bone fractures. Evonik's polymer composite contains 30 percent ceramic additives. As a result, the component is more stable and also releases calcium to promote bone formation. After a given time, the implant then dissolves completely.

In addition, another innovative absorbable material from Evonik was recently processed with the Freeformer: A polymer from the Resomer C family, which can be used in the soft tissue area.

Patient-specific sawing templates

The high-temperature plastic Ultem 1004, on the other hand, is ideal for medical technology due to its versatile sterilisation possibilities and biocompatibility (ISO 10993, USP Class VI). As an example, this material can be used to additively manufacture patient-specific sawing templates, which are then used as fixing aids during knee surgeries. Other materials for medical technology applications are currently in the trial phase.

Freeformers are suitable for clean room use

With a few small adjustments, all Freeformers are suitable for use in clean rooms, as customers have already proved. They are low in emissions and create no dust, and their build chamber is generally made out of stainless steel. An optional robot interface enables the additive production process to be automated and the Freeformer to be integrated into production lines connected via an IT network. The process quality can be reliably documented and the components clearly tracked, where necessary.



The Freeformer can produce complex and resilient functional components from qualified original plastics and support material. The machine is also suitable for use in clean rooms. (Photo: Arburg)

Fraunhofer IPA presents disinfection robot “DeKonBot”

In order to contain the spread of the coronavirus, the research institute in Stuttgart has developed the prototype of a mobile cleaning and disinfection robot in a short time. It navigates autonomously to potentially contaminated objects, such as door handles, and disinfects them thoroughly. The robot is gentle on resources and time-saving.

The new prototype of the mobile disinfection robot “DeKonBot” is an automation solution that independently cleans and disinfects potentially contaminated areas such as door handles, light switches, or elevator buttons. Compared to cleaning by hand, the use of robots

reduces the risk of infection for the cleaning staff and at the same time ensures that the cleaning task is carried out reliably and traceably. The continuous use of the robot, even during the night, means that cleaning jobs can be performed more frequently than if carried out manually.

Targeted and safe disinfection

Compared to available robot solutions on the market, DeKonBot has a few different features. On the one hand, it cleans relevant surfaces in a targeted and direct manner and does not spray the disinfectant over large areas in the room like some other robots. This not only saves on disinfectants and time because the surface to be cleaned is limited to the essentials, but also prevents hazards such as slipping on damp surfaces or inhaling potentially harmful chemicals. On the other hand, DeKonBot can be used safely in the presence of people. For safety reasons, disinfection robots that use UV rays to kill viruses, for example, require an environment where no people are present.



The mobile cleaning and disinfection robot DeKonBot navigates autonomously to critical objects such as door handles and disinfects them. (© Fraunhofer IPA/Photo: Rainer Bez)

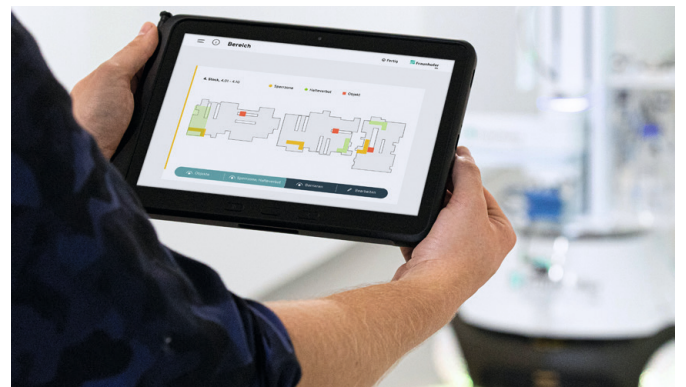

The operating environment is taught to the robot via an intuitive graphical user interface. (© Fraunhofer IPA/Photo: Rainer Bez)



By using its flexible cleaning tool, DeKonBot can disinfect different objects by wiping, including elevator buttons. (© Fraunhofer IPA/Photo: Rainer Bez)

Fraunhofer IPA presents disinfection robot "DeKonBot"

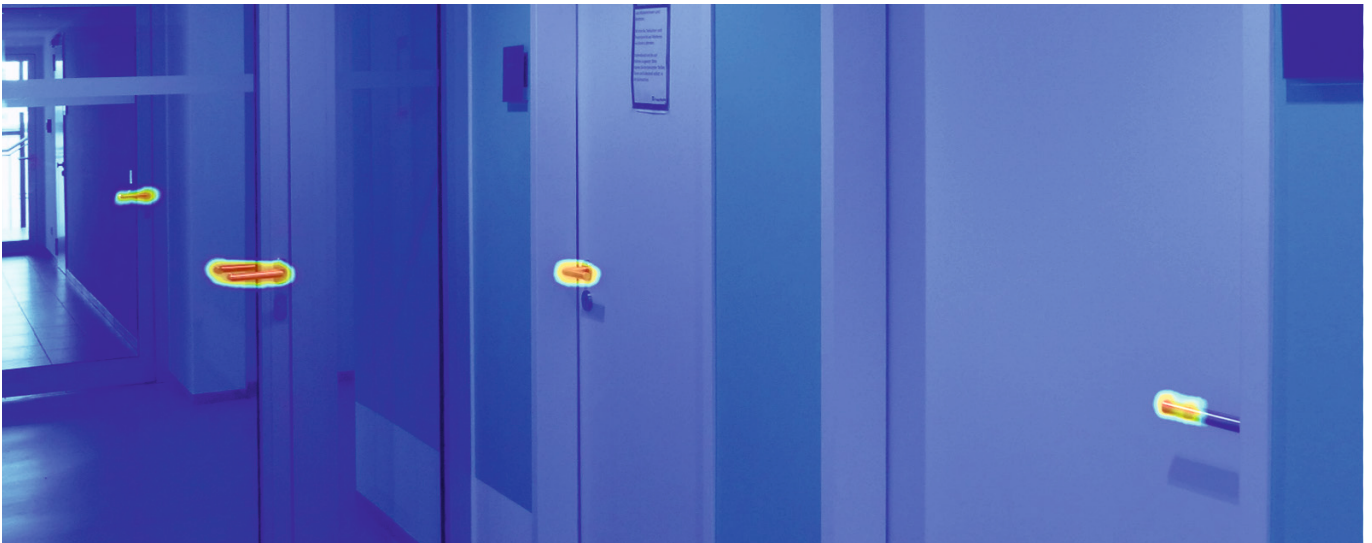

Machine learning methods make it possible to detect the objects to be cleaned in the area, in this case door handles in a corridor. (© Fraunhofer IPA)

In order for DeKonBot to work successfully, it is initially trained in its new operating environment with the help of a tablet that can be operated without expert robotics knowledge. First of all, the member of operating staff navigates the robot once through the environment, during which it independently creates a map of its operating environment. In addition, the user "shows" the robot the objects to be cleaned and the cleaning movement to be performed: For this purpose, the user guides the robot arm with the disinfection tool to the door handle, for example, and moves the tool as required to clean it. The robot saves the path and is subsequently able to repeat it independently.

The objects to be cleaned are currently still recognized by means of so-called "tags", i.e. small, black-and-white labels. The robot positions itself relative to these tags. In the future, tags will no longer be needed. Instead, methods recently developed at Fraunhofer IPA will be used, which on the one hand enable these objects to be automatically recognized in camera data. On the other hand, a new 3D sensor, which was developed in the course of the project, recognizes the objects to be cleaned and their position in the room better than other sensors available on the market, even if these objects have a metallic, reflective surface.

Rapid joint development

The prototype is the result of a joint development of the IPA departments "Robot and Assistive Systems", "Laboratory Automation and Biomanufacturing Engineering" together with "Ultraclean Technology and Micromanufacturing". DeKonBot received funding from the Fraunhofer-Gesellschaft's internal "Anti-Corona" program, in which it is carrying out comprehensive research and innovation activities to combat the pandemic.

The development of the service robot proceeded rapidly. Already in April of this year, a first feasibility study was carried out, in which a simple spray tool was still used for disinfection. "Just four months later, we were able to put the disinfection robot with its new wiping tool into operation - despite the limitations that the coronavirus pandemic also caused for us Fraunhofer employees", explains Birgit Graf, Manager of the "Household and Assistive Robotics" group and manager of the DeKonBot project.

The development of the prototype profited from extensive preliminary work carried out by the institute in the field of mobile service

and cleaning robotics. For example, the mobile platform of the robotic home assistant Care-O-bot® 4 was used, which is already being sold as a serial product by an IPA spin-off. Existing software modules for navigation, 3D object recognition and manipulation could be further developed specifically for the application. Currently, first field tests are being performed with the robot in the offices at Fraunhofer IPA. Later, employees from a cleaning company will test the robot in an external building. Until the end of the project in February 2021, the robot will be further optimized based on the test results. Measurements of the bacterial load in the disinfected areas will be used to verify the benefit of the robot.

In addition, the research project "Mobile Disinfection" (MobDi), also funded by the Fraunhofer-Gesellschaft and starting in October this year, will be focusing on and further developing DeKonBot technologies. In particular, new disinfection methods and tools, as well as more complex detection and planning methods, will be developed in the course of the one-year project period, thus enabling disinfection robots to plan the cleaning and disinfection process systematically.

Production readiness in view

DeKonBot has not yet reached its full range of functions but researchers at Fraunhofer IPA have already developed a concept for a later serial product. "Together with interested companies, we would like to put the service robot into practice and thus make a contribution to restarting public life even in times of the coronavirus," says Graf, stating the next goals. Several cleaning companies that were actively involved in the development of the robot have already expressed their interest in using DeKonBot.



Fraunhofer-Institut für Produktionstechnik und Automatisierung IPA
Nobelstraße 12
D 70569 Stuttgart
Telefon: +49 711 970 1667
E-Mail: joerg-dieter.walz@ipa.fraunhofer.de
Internet: <http://www.ipa.fraunhofer.de>

A new OSD Customer Center in Waiblingen

- From development to production of oral solid dosage forms
- Six times more cleanroom capacity for customer projects in Waiblingen
- Test possibilities up to OEB level 5 (highest containment)
- Optimum customer service thanks to experienced team of pharmacists, chemists, engineers and process specialists

After a one-year construction phase, Syntegon Technology inaugurated its new OSD Customer Center in Waiblingen, Germany, on November 16, 2020. The 600 square meter building includes everything customers from Syntegon need for the formulation, development and production of their oral solid dosage (OSD) forms – from cleanrooms and assembly areas to offices, meeting and training rooms. “With this infrastructure and our team of experts, we offer our customers exactly the innovative power they expect from a reliable and future-oriented partner,” says Dr. Thomas Brinz, head of the new OSD Customer Center.

In the new OSD Customer Center, Syntegon’s clients will meet with experts who

take care of problem solving, as well as optimizing and developing their processes and providing seminars and training. Syntegon has increased the cleanroom capacity at its site in Waiblingen sixfold. From laboratory equipment to production scale machines, TPR tablet presses for mono and bilayer tablets as well as GKF capsule filling machines are available for all formats and products in different cleanroom classes – up to the highest containment level OEB5.

Bridging the gap between drug development and production

The new OSD Customer Center offers

pharmaceutical developers and manufacturers an ideal location to test future formulations or existing products on real machines. “From the development of active ingredients or formulations to process optimization or machine operator training – we bridge the gap between all these disciplines,” says Brinz. Since Syntegon’s customers don’t just want to test their filling parameters on production equipment, “we also offer them the process analysis of active ingredients and formulations, as well as the diagnosis of existing processes. Especially for powders, we can now offer more comprehensive services,” as Brinz explains.

To develop optimum parameters, Syntegon uses the newly developed “Automated Process Development” (APD) tool, which is also suited for active ingredients or formulations that have not yet been approved. “Manual evaluations of process parameters can take days or even weeks,” Brinz explains. “The APD tool achieves not only faster, but also more precise results.” By determining the interactions between material, quality and process-critical parameters, the tool ensures an improved understanding of the process, which in turn has positive effects on the quality of the end product.

Worldwide laboratory competence

The OSD Customer Center provides customers with a ten-strong core team of pharmacists, chemists, process specialists, engineers, trainers and service technicians. “Depending on the customer project, we can flexibly call in additional specialists from different areas,” says Brinz. “This way, we help our customers to design their capsule filling and tablet pressing processes much more efficiently, and to increase their overall plant effectiveness. In addition, we are now also able to expand our range of training courses and seminars.”

The OSD Customer Center in Waiblingen complements the range of specialized laboratories and customer centers at Syntegon. Waiblingen is the third facility for solid oral dosage forms next to Schopfheim in Germany and Hangzhou in China. In addition, five partner laboratories provide optimum advice to pharmaceutical developers and manufacturers around the world. “The OSD Customer Center in Waiblingen is the logical next step towards even stronger customer orientation and flexible services,” says Brinz.



The 600 square meter building includes everything customers from Syntegon need for the formulation, development and production of their oral solid dosage forms – from cleanrooms and assembly areas to offices, meeting and training rooms.



Apart from the GKF 720 HiProTect, the OSD Customer Center in Waiblingen offers many further machines to customers for all formats and products in different cleanroom classes – up to OEB5.

Gerresheimer mold making in China certified

To date, injection molding tools have been maintained and optimized at the Gerresheimer location Dongguan (China). Since certification according to DIN ISO 9001 in July 2020, the company now also builds complete molds. Gerresheimer in this way makes itself more independent of local mold makers and can offer the professional, cost-efficient construction of injection molding tools for its customers extending beyond its own needs.

Mold prototypes are produced by a team of 8 employees for our customers at the Dongguan location. The maintenance and optimization of molds are still part of the service offering. In addition to this, molds for series production in Asia, Europe, and the USA

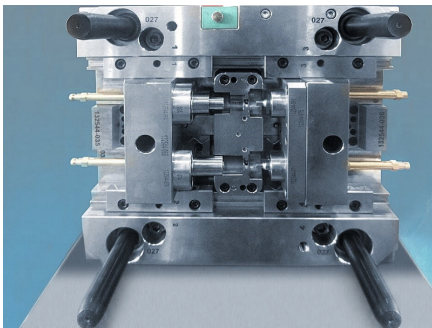

Since certification according to DIN ISO 9001, the Gerresheimer location in Dongguan (China) company now also builds complete molds.

are manufactured there. "With the expanded portfolio of offerings in mold making, we adjust to the needs of our various customer segments. In the pharmaceuticals and medical technology markets, cost-efficient molds that can be delivered quickly for start-ups and development projects are required. We now offer the appropriate solution for precisely this," explains Manfred Baumann, Global Executive Vice President Sales & Marketing, Administration & TCC, Gerresheimer Medical Systems.

Mold making in Dongguan consciously understands itself not as competition, but instead as supplementing the more comprehensive offering of services at the German location of Wackersdorf. While highly complex, high-cavity molds can be built for pharmaceutical and medical technology large series production there, the offering of services in China is limited to molds with an average de-

gree of complexity. What really distinguishes mold making in Dongguan much more is the combination of German quality standards with the speed and the attractive prices of the China location.

Gerresheimer already started in 2018 with redesigning its department for mold maintenance and optimization at the South Chinese production location in Dongguan into a full-fledged mold making facility. In 2019, a start was made toward creating the process description, which is the prerequisite for certification according to the quality management standard DIN ISO 9001. The certification audit then took place in May 2020 – for the first time in an online process due to the corona pandemic. The quality management system of the location is now certified by the DQS, taking effect on July 19, 2020.

Gerresheimer AG D 40468 Düsseldorf

Digital Medication Management plus First-Opening Indication

Equipping syringes containing liquid medications with RFID-Labels poses a challenge. Both the container material and the composition of the liquid may impair reading of a UHF RFID-Label. Flag labels protruding from the container are frequently used for this purpose. However, they can easily tear



With the Cap-Lock version complemented by an RFID-Label, digital medication management and digital first-opening indication are now possible as well.

off, require additional space and have to be manually applied.

With Cap-Lock plus RFID, the RFID chip is integrated in the label. Cap-Lock is a combination of a cap adapter and label. The adapter is placed on top of the syringe's primary closure and interlinked with it to equalize the diameter differences of the syringe body and closure. The label wraps around the syringe body and cap adapter and—once opened—provides irreversible tamper evidence due to an integrated perforation. The RFID inlay is located in the upper part of the label at the level of the cap. Thus, it largely sits outside the liquid-filled area and enables reliable long-range reading. Due to the RFID functionality, digital first-opening evidence is now possible in addition to the previous, purely visual first-opening indication provided by the destroyed label. The RFID-Label can be automatically processed as part of the primary container's normal labeling workflow.

For live monitoring and control of the logistic flow of materials and products in

automated inventory and supply chain management, the data of syringes equipped with RFID-Labels can be automatically captured at various stations. As a result of reading the picked and placed products, current inventory information is consistently stored in a database. Additionally, integrity, first-opening or tampering with containers can be digitally monitored by means of the purpose-developed RFID-Sensor-Label.

In medication management, the data—such as product name, manufacturer, batch number and expiration date—stored on the RFID-Labels are read automatically either individually or in bulk using simple handheld or specialty readers and matched with a data base. This enables exact tracking of inventories and provides transparency about medicines that are missing or approaching their expiration date. Thus, patients are protected against potential medication errors.

Schreiner MediPharm
D 85764 Oberschleissheim

Manufactured at 180 degrees Celsius build chamber temperature: Toothed wheels and spring elements made of Ultem 9085, a high-performance plastic approved for aerospace applications.
(Photo: Arburg)



High-temperature applications

- **Wide range of materials:** Freeformer 300-3X for high-temperature plastics
- **Sample use:** Processing of materials based on PEI
- **Predestined:** Sterilisable and biocompatible Ultem HU 1004 for medical technology

The Freeformer 300-3X is specially designed for the processing of high-temperature plastics, and has a build chamber that can be heated up to 200 degrees Celsius. This means that the range of Arburg Plastic Freeforming (APF) materials can be expanded to include materials based on PEI, such as Ultem 1004 and Ultem 9085.

The presentation at the Formnext Connect 2020 includes the Freeformer 300-3X with a build chamber temperature of approx. 180 degrees Celsius. It processes materials based on polyetherimide (PEI) into medical and technical components, such as drilling and sawing templates, toothed wheels and spring elements.

Patient-specific saw templates

The high-temperature plastic Ultem 1004 is ideal for medical technology due to its versatile sterilisation possibilities and biocompatibility (ISO 10993, USP Class VI). As an example, this material can be used to additively manufacture patient-specific sawing templates, which are then used as fixing aids during knee surgeries. Other materials for medical technology applications are currently in the trial phase.

High-temperature plastic for aerospace applications

The PEI/PC blend Ultem 9085, on the other hand, is a high-strength and flame-retardant original material that is approved for aerospace

applications and also meet the fire protection requirements for rail vehicle construction.

Broad spectrum for industrial additive manufacturing

Together, the Freeformers 200-3X and 300-3X cover a wide range of industrial additive manufacturing applications. While the Freeformer 200-3X is equipped with two nozzles as standard, the Freeformer 300-3X can process three components to produce complex functional components in resilient hard/soft combinations with support structures. With an adapted build chamber and closed cooling system with industrial cooling water connection, even complex parts can be manufactured from high-temperature materials.

Users can process their own original materials and optimise droplet size as well as process control themselves with the open system. Alternatively, they can access Arburg's material database with reference materials.

Opening a new prototyping centre

From the feasibility study to small series production

The demand for electric cars is constantly increasing. New types of components are therefore necessary and their production must be perfected. For example, battery trays protect the sensitive batteries from external influences – even in the event of a crash. However, there are few welding processes that are suitable for joining the aluminium components used solidly and with low levels of distortion. Thanks to its new prototyping centre, Fronius is the specialist for this and other similar applications.

From the beginning of December, Fronius will be offering car manufacturers, their suppliers, and integrators the option to outsource prototype construction. In the new prototyping centre in Wels (Upper Austria), Fronius welding technology specialists will work with customers to develop the ideal solution for joining their components, starting with the design phase, feasibility studies using simulations, welding process evaluation and welding trials, through to various quality checks and project support. In addition to prototype production with all its various phases, Fronius also manufactures smaller quantities of customer components for pre-series production if required. Fronius therefore offers a complete solution for prototype construction.

As a result, car manufacturers can benefit from considerable savings potential, increased efficiency, and minimization of risks. By outsourcing the production of prototypes, development costs, time-intensive labour, and investments in dedicated prototyping centres are eliminated. What's more, customers benefit from Fronius' extensive welding expertise and the associated state-of-the-art technologies.

Premium welding technology for prototype construction

Covering more than 900 square meters, the prototyping centre provides sophisticated simulation, welding, and measuring technology. This makes it possible to manufacture components measuring up to 3x2 meters and weighing up to 1,500 kilograms. The facilities are sealed off from other areas and guarantee absolute discretion.

One of the two robot welding cells used is equipped with Fro-

nius CMT technology. The heat-reduced welding process is suitable for almost any parent material, especially light-gauge sheet metal, and reduces spattering and distortion. The flexible TPS/i welding system platform used for this purpose also allows other welding processes to be employed if required. In addition, the robot cell uses an Acerios surface cleaning system that pre-treats the edges of the components using hot plasma technology. This creates the perfect conditions for high-quality welding seams.

The second robot welding cell features both a laser and a powerful GMAW welding system. In conjunction, the LaserHybrid process combines the advantages of both worlds and thus offers excellent gap-bridging ability and high welding speeds. Deep penetration and low heat input – and thus minimal component distortion – also go hand in hand here.

Sensor technology, measurement, and data documentation

Both welding cells are equipped with sophisticated robot assistance and control systems:

- A laser monitoring system mounted on the welding torch ensures that the robot welds in exactly the right location. In case of misalignment, distortion, or tolerances that are common in production, the robot can automatically correct the pre-programmed weld seam path and welding is performed reliably at the correct position.

- Fronius SeamTracking provides another option: This function relia-



The robot welding cells in the Fronius prototyping centre are equipped with the latest clamping, sensor, and welding technology – such as the CMT process. (Photo: Fronius International GmbH)



The LaserHybrid process ensures fast, reliable seams with low levels of distortion – especially for large components such as battery trays. (Photo: Fronius International GmbH)

Fronius opens a new prototyping centre

- bly detects the component edge through welding torch pendulum movements for fillet and prepared butt welds.
- In addition, the ArcView camera system provides a direct view of the arc, enabling the welding process to be monitored precisely. If necessary, the welder can immediately take corrective action.
 - What's more, an automated weld seam inspection system scans the seam after the welding process and immediately performs a visual quality inspection.
 - At the same time, the WeldCube data documentation software monitors and stores all relevant data from the welding process and enables clear traceability of each seam.

In addition to highly developed welding processes and the



Battery trays protect the batteries of electric cars from environmental influences or even in the event of a crash – the demands on the welding seams are therefore high. Thanks to the new prototyping centre, Fronius is the specialist for these and similar innovative components. (Photo: Fronius International GmbH)

monitoring of these processes, the component is measured three-dimensionally in a dedicated robot cell after welding, which allows any deviations such as tolerances or distortion to be accurately detected. This precise monitoring of the exact dimensions thus takes place from an early stage in the prototype construction, enabling a quick response and adjustment of various parameters (e.g., welding sequence, welding parameters, and clamping technology) and saving time and costs both during development and in the subsequent production ramp-up. Fronius also offers its customers the option of subjecting the prototypes to metallurgical testing in the laboratory.

Fronius International GmbH A 4643 Pettenbach



After welding, the component is checked in the measuring cell (computer rendering). (Photo: Fronius International GmbH)

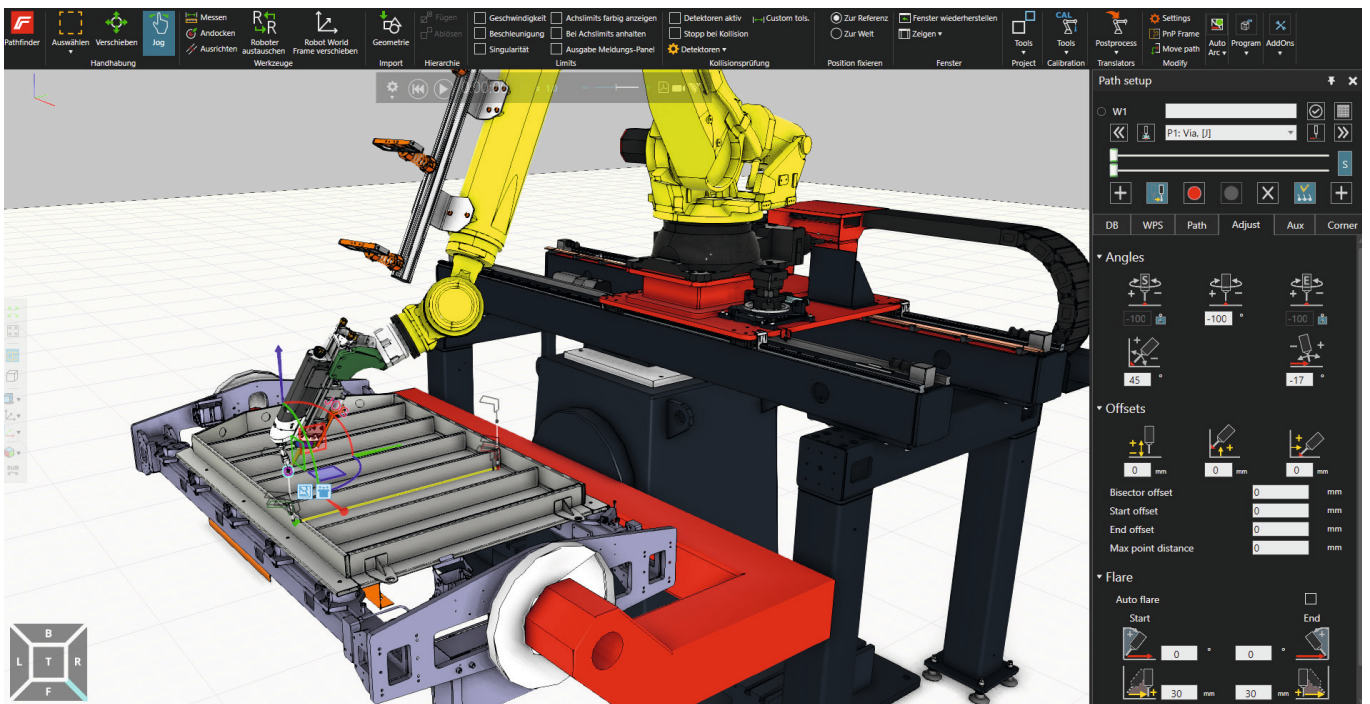

The simulation software enables cycle times to be determined and accessibility to be checked for the feasibility study, as well as offline programming. (Photo: Fronius International GmbH)

Disseminating knowledge for injection moulders – remotely and on site

ENGEL France opens new training centre

ENGEL France opened a new training and education centre at the Wissous location. The idea behind this is to stage injection moulding 4.0 hands-on, for trials and to improve understanding with state-of-the-art machinery. In times fraught by the pandemic, virtual options are also offered for all training courses for setting up, programming and optimising injection moulding machines thanks to the digitalised training centre.

Located in the direct vicinity of Paris, the new ENGEL France training centre can be reached very easily. With its „feel, experiment and understand“ strategy, the centre is perfectly geared for face-to-face events. Thanks to consistent digitalisation, a great deal of customer proximity is also achieved „remotely“ in the age of Covid-19.

Perfectly prepared for advanced virtual training

The training room plays the main role here: digitally equipped with the best possible equipment and with the support of the Virtmould simulation tool, online webinars are held from here. Virtmould allows the injection moulding machine's control interface to be displayed on a PC screen and the machine to be operated from the PC.

The content is not limited, irrespective of the training mode. „The topics in the comprehensive training catalogue satisfy specific knowledge needs for set-up personnel, explain robot programming and support the optimisation of injection moulding processes“, says Romain Reyre, General Manager of ENGEL France, whetting injection moulder's appetite for learning at ENGEL France. Where face-to-face training is still possible under Covid-19 rules, the state-of-the-art training room with its individual computer workstations can be used for a maximum of eight participants – without any machine noise from the technology centre.

Training directly on the machine

At the technology centre, a total of 200 m² of floor space is available to the training

participants for practical exercises. There is an e-victory injection moulding machine with a clamping force of 80 tonnes and an electric injection unit, equipped with a viper linear robot and a variety of modules from the ENGEL inject 4.0 range. The iQ weight control and iQ flow control smart assistance systems are available for trials, along with other systems. This is the perfect way to experience the new opportunities which digitalisation offers in the injection moulding process directly at the machine. Production automation and robot programming can be tried out and learned in different constellations: an e-pic robot and an easix articulated robot are also available to the training participants.

„The pandemic has shown us how important it is to stay in close contact with our customers, also with virtual training courses“, says Reyre: „The future is hybrid. Remote offerings and webinars will have their place side by side with on-site training courses. This will enable us to respond even better to the individual requirements of our customers, for whom we are increasingly becoming a partner over the entire life cycle of our injection moulding machines and system solutions.“

ENGEL AUSTRIA GmbH A 4311 Schwertberg



At the new ENGEL France training centre, the latest production technology is ready to be „touched, tried out and understood“ on 200 square metres of floor space. (Picture: Engel)



The training room offers space for eight participants and a quiet learning environment – but also the best conditions for virtual knowledge transfer. (Picture: Engel)

Needle-Trap Wins in China

Asian Award for Needle Protection System from Schreiner MediPharm

Schreiner Group based in Oberschleissheim (Germany) has previously received numerous national and international awards for Schreiner MediPharm's Needle-Trap. Now the innovative needle protection system has won recognition for the first time also in the Middle Kingdom: In the competition of the Chinese packaging and printing industry association, it was selected for a Gold Award in the "Labels" category.

The China Packaging Federation (CPF) and the Pharmaceutical Packaging Printing Committee of the China National Pharmaceutical Packaging Association (CNPPA) have been organizing the competition since 2014. Divided into various categories such as food and semi-luxury food packaging, soft packaging and labels, the product entries are evaluated under the aspects of outstanding design, technical innovation, printing technology and printing quality. In the "Labels" category, Needle-Trap won a first price in the competition.

The awards ceremony took place in September as part of the "Suzhou Dialogue" event in Suzhou (Jiangsu province, west of Shanghai). This annual conference is organized by the CNPPA. Jamie Long, General Manager of Schreiner Group at the company's Chinese location in Fengpu near Shanghai, accepted the prize: "Made in Germany" is highly valued



Needle-Trap helps avoid Injuries.

in our country because German products have a reputation of trustworthiness and reliable performance. I'm very proud that Needle-Trap, which was developed at our German headquarters more than ten years ago, has won in a Chinese competition."

Needle-Trap is a unique, active needle protection system for prefilled syringes. It consists of a label-integrated needle trap that secures the syringe needle after an injection. This mechanism helps prevent accidental needlestick injuries. More than 1 billion Needle-Traps have been produced since the product's market launch in 2009. It is used for prefilled syringes by renowned pharmaceutical manufacturers in Europe, North and South America, Asia and Africa.

Schreiner MediPharm D 85764 Oberschleissheim

New member of the Executive Board and establishment of new jobs

MBV grows and expands its Executive Board by Norbert Schorpp. As a new member of the Executive Board, Norbert Schorpp will take over full responsibility for the internal value chain as Chief Operating Officer (COO). As a proven expert with many years of management experience, Norbert Schorpp has the ideal qualifications to take an active part in the continuous development of MBV towards our customers.



Norbert Schorpp joins the Executive Board of MBV with immediate effect as Chief Operating Officer (COO). He is already over 10 years Managing Director of the sister and production company Femron. His mandate as Managing Director at Femron remains unchanged in addition to his new function at MBV. Femron specializes in the precise

manufacture of metal parts for products in the cleanroom and medical technology industry. One main product is the MAS-100 viable air sampler from MBV, for which Femron produces most of the parts and assembles the high-precision, high-quality monitoring instruments.

With Norbert Schorpp joining the Executive Board of MBV, the two sister companies are growing even closer together. Due to his many years of experience at Femron, Norbert Schorpp is very familiar with the MAS-100 product line and brings valuable additional experience in the field of environmental monitoring. In his new dual function, he

is responsible for the entire internal value chain. MBV is thus taking a further important step towards an even more efficient and effective process for the benefit of its demanding customers.

In addition to the growth in the Executive Board with Norbert Schorpp, MBV continues to expand and establishes multiple new jobs in corporate and product development.

The Board of Directors and the Executive Board are very pleased with the positive dynamics and the growth in MBV as well as the forthcoming collaboration with Norbert Schorpp in his new function.



LUFT. SONST NICHTS.

MBV AG
Microbiology and Bioanalytic
Industriestrasse 9 CH 8712 Stäfa
Telefon: +41 44 928 30 80 Telefax: +41 44 928 30 89
E-Mail: welcome@mbv.ch Internet: <http://www.mbv.ch>

Stefan Krömer appointed new Managing Director alongside Jens Carstens

Romaco Kilian restructured

Romaco Kilian will be under new dual leadership from now on: Stefan Krömer has just been appointed as the new Managing Director of the Cologne-based tablet press manufacturer. He will run the company together with Jens Carstens, who has been Managing Director of Romaco Kilian since 2013.



Stefan Krömer has just been appointed by Romaco Holding GmbH as the new Managing Director of Romaco Kilian GmbH. In his new role, he is responsible for all aspects of the Cologne tablet press manufacturer's operations and administration. Mr. Krömer will share the running of the company with Jens Carstens, who has been at the helm since 2013. Jens Carstens, already Managing Director Technology, has additionally been made responsible for Sales and Customer Service. Mr. Krömer's area of responsibility will include the Finance, Human Resources, Technical Purchasing and Quality departments as well as Assembly and Production.

Stefan Krömer – a manager with extensive experience

"With Stefan Krömer, we have gained a highly qualified manager with extensive top-level experience for the management of Romaco Kilian", emphasised Jörg Pieper, CEO Romaco Group. "Due to his proven expertise in process optimisation, controlling and production planning, Mr. Krömer will make a vital contribution to Romaco Kilian's future growth."

Prior to joining Romaco Kilian, Stefan Krömer was General Manager of Jensen GmbH, a leading manufacturer of high-performance washroom machinery and systems. At a global level, he was simultaneously Head of the Jensen Group's Washroom Technology division. In the course of his successful career, Stefan Krömer has worked for various international players offering a wide range of engineering solutions. A native of the German state of Lower Saxony, he gained a degree in Mechanical Engineering and subsequently held a number of executive positions with broad responsibility for budgets, personnel and products.

"The engineering industry is my home. Indeed, moving to Ro-

maco Kilian marks my first job in the pharmaceutical sector. It's new ground and I'm very much looking forward to it." Yet Stefan Krömer is convinced: "It doesn't matter what industry you work in – high quality and short delivery times are key priorities for customers everywhere. We're endeavouring to strengthen and expand Romaco Kilian's position as a leading international supplier of tableting solutions, and my new role is a chance for me to make a lasting contribution."

Kilian management restructured

Stefan Krömer's appointment coincides with the restructuring of the Romaco Kilian management. Jens Carstens, Director Technology at Romaco Kilian GmbH since 2013, has additionally been made responsible for sales and customer service. He has been a Romaco Kilian employee for nearly 30 years now, amongst other things as Head of the Research & Development department. The new organisational structure will enable Romaco Kilian to focus even more strongly on the market and its customers' desire for innovative but workable technologies.

"If you want to be successful at acquiring and realising customer projects, it's enormously important to have technical and commercial departments that work together very closely", Jörg Pieper, CEO Romaco Group, concluded. "That's why we decided to merge these two areas of responsibility at Romaco Kilian into one. Jens Carstens at the head is the ideal choice. At the interface between markets and technologies, he can reconcile different interests better than anyone else I know."

Romaco Group
D 76227 Karlsruhe



Stefan Krömer, Managing Director of Romaco Kilian GmbH.



Jens Carstens, Managing Director of Romaco Kilian GmbH.

Valicare extends GxP expertise

Valicare GmbH, a wholly owned subsidiary of Syntegon, now offers additional services along the entire product life cycle of pharmaceutically and biotechnologically produced drugs. A new focus is on consulting services for the transition of products from the development phase to the GMP compliant manufacturing of investigational medicinal products. These services are complemented by the presentation and assessment of market-specific requirements, investigational drug management and the necessary regulatory interactions.



Christin Erbach

Addition to the team

To underline the extension of the service portfolio, Valicare has recruited Dr. Christin Erbach to join the expert team of engineers and scientists as a Senior GMP Consultant. Dr. Erbach has more than ten years of clinical service experience along with

deep knowledge in quality management and legal pharmaceutical requirements. She also successfully supported pharmaceutical businesses during their establishment phase. "Her specialized knowledge in the area of clinical services combined with her legal background is an outstanding addition to Valicare's consultancy business," says Dr. Hans-Georg Eckert, site manager of Valicare in Frankfurt. "She will strengthen our competencies regarding the first GMP steps and the legal requirements for clinical products, addressing special needs for each development stage. This way, we are able to extend our approach of accompanying products along their complete life cycle."

Valicare is significantly expanding its GxP and consultancy services for the pharma, biotech and ATMP industries to fulfill individual demands regarding products and projects from development to market release. As far as ATMPs are concerned, the company already supports customers in meeting regulatory requirements for more and more individual therapies and minimizing associated risks. Valicare also offers complete solutions for the production of ATMPs as well as consulting and supporting services, right through to the production of the first investigational medicinal products.

Syntegon Technology D 71332 Waiblingen

Dr Christian Lau assumes overall responsibility for manufacturing within the MULTIVAC Group

As Executive Vice President for Manufacturing, Dr Christian Lau becomes responsible with immediate effect for manufacturing within the MULTIVAC Group. As part of this function, he also becomes Managing Director of the two subsidiaries, MULTIVAC Lechaschau and MULTIVAC Bulgaria Production, as well as Chairman of the Board of MULTIVAC Taicang (China). MULTIVAC is an important employer in Tyrol: The specialist packaging company has had a production site for more than 45 years in Lechaschau, where it currently employs around 340 staff.



Dr. Christian Lau

Dr Lau has been at MULTIVAC since July 2010, and in his most recent role as Executive Vice President he has been responsible for the Thermoforming Packaging Machines Business Unit. He studied Business Administration and Engineering at the University of Karlsruhe, and he subsequently gained his doctorate in Production Technology at Munich's Technical University.

"One of MULTIVAC's main features has always been its high level of in-house vertical manufacturing, which enables it to meet the requirements of highest quality and greatest innovation. It is for this reason that the company's Manufacturing Division with around 1000 staff has a very high status," explains Guido Spix, Group President of MULTIVAC. "Working in close cooperation with all our manufacturing business units, Dr Lau will drive forward our supply

chain strategy to the ongoing benefit of our customers."

As a consequence of the management change, Mr Andreas Schaller, who had previously held the role, is leaving the company. "We would like to thank Mr Schaller for his many years

of successful work at MULTIVAC. He was responsible from 2003 for running the business in Lechaschau, as well as from 2005 for successfully managing the Manufacturing Department at MULTIVAC, and in 2018 he made a significant contribution to the successful establishment of our new production company in Bulgaria."

MULTIVAC Maschinenbau Ges. m.b.H. & Co. KG was founded in 1974 in Lechaschau as an additional production site, in order to meet the growing demand for packaging machines. Since then the factory has been continuously expanded and has taken on new areas of responsibility. The activities there today include the production of stainless steel machine components, as well as the manufacture of basic machine frames, film punches and sealing gaskets. About 340 employees currently work at the Lechaschau site. Its own Training Center, which was opened in 2014, is responsible for training apprentices in technical professions.

MULTIVAC Sepp Haggenmüller GmbH & Co. KG
D 87787 Wolfertschwenden

analytica 2020 with very good results in the digital format

- analytica 2020 largest virtual platform of the laboratory industry
- An average of more than 5000 visitors per exhibition day, of which 50 percent from abroad
- No. 1 topic digitization / lab of the future

analytica 2020 successfully concludes five days of virtual trade fair and presentation formats: A total of 21,641 participants (unique users) from 152 nations took part in the world's leading trade fair for laboratory technology, analysis and biotechnology, which was held for the first time in purely virtual fashion from October 19 to 23. Here, 268 exhibitors from 24 countries presented more than 700 product highlights. There was a total of more than 33,000 participations in the 200 exhibitor webinars and the 119 scientific presentations at the analytica conference. No. 1 topic: digital transformation.

Dr. Reinhard Pfeiffer, Deputy Chairman of the Management Board of Messe München: "Many customers in all areas of our trade fair business say that in particular acquisition of new customers is possible only to a limited extent via virtual platforms. Nevertheless, many analytica customers now emphasized that it was proper and important to hold analytica virtual in times of corona. The result consolidates analytica's position as the world's leading trade fair. At the upcoming presence fair in June 2022, we will use the knowledge we have now gained, and expand our range of offerings digitally."

Messe München organized analytica virtual 2020 in cooperation with LUMITOS AG.

High foreign share

The 24-hour accessibility of the digital platform for easier global access proved worthwhile: analytica 2020 had the highest international share in its history. 50 percent of the overall 21,641 participants (unique users) did

not come from Germany. Second to Germany, the top user countries were (in that order): Switzerland, USA, United Kingdom, Austria and India. Evaluation showed a strong influx of participants from Asia in the morning hours of Central European Time, while in the evening and night hours many Americans frequented the platform. On average, some 5,000 participants attended the virtual analytica on each of the five days of the event – at peak times even more than 7,000.

For optimum orientation, the booths of the 268 international exhibitors were grouped into six virtual exhibition halls. These were dedicated to the areas of Premieres, Analysis & Measurement Technology, Laboratory Technology, Biotech & Bioanalytics, Diagnostics & Medicine, and Start-ups. The restriction to a maximum of four products presented per booth, which was necessitated by technical limitations, ensured that only absolute highlights and innovations were shown. Visitors could contact exhibitors directly via text, audio or video chat.

Strongly booked presentation program with the No. 1 topic digitization

From the extensive presentation program, topics related to digital transformation, laboratory automation and data management were in particular demand. More than 24,000 participations were registered for the 200 exhibitor presentations.

The analytica conference was able to maintain its outstanding class. With 2,126 visitors, it reports the same figures as the record event in 2018. The systems registered more than 9,300 participations for the 119 presentations.

All the presentations were repeated several times during the five days of the event.

Positive comments from exhibitors

Exhibitors' statements underscore the success of analytica 2020: "We as Merck found the Premiere Hall is giving high visibility to our innovations. We are pleased that the virtual platform offer Webinars as mean to share knowledge and skills they are highly attended and have an international reach. We are definitely looking forward to get back together at Analytica 2022 and give hands-on demonstrations at the Live Labs," says Dr Véronique Batifort, Head of European Conferences and Exhibitions Research & Applied, Merck Life Science.

Ruben Lonneville, Global Marketing Manager, Customer Engagement at Thermo Fisher Scientific, confirms: "Analytica virtual was a good opportunity to connect with our customers. The ability to present new product innovations in a virtual way and respond to customer questions in real time has been a valuable part of the virtual show. analytica

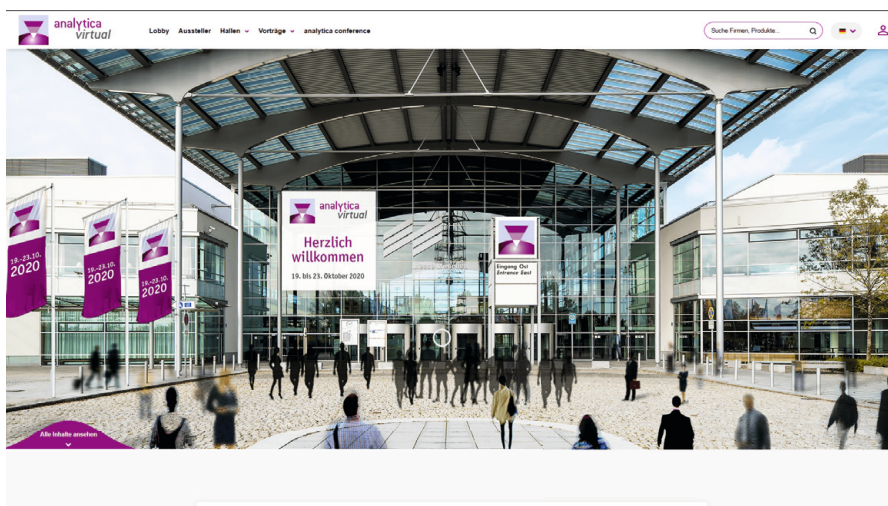

analytica 2020 with very good results in the digital format

will continue to be an important platform for us in the future to connect and collaborate with our valued scientists. While we all hope that a return to an in-person show will be possible in 2022, we strongly believe, that the future of analytica should evolve to a combined live and virtual experience."

Susanne Grödl, Exhibition Director at analytica, adds: "We have succeeded in providing the industry with an optimal platform to present itself globally for 24 hours a day, de-

spite the contact and travel restrictions currently in force. We have achieved our goal of giving greater visibility to the laboratory sector, which is particularly important in these times. Now we are looking ahead and already forward to seeing you again at analytica 2022."

The next analytica will take place from June 21 to 24, 2022, as a presence fair on the fairgrounds of Messe München. On this particular occasion, the event will be held concomitantly with automatica, the leading trade

fair for intelligent automation and robotics, and ceramitec, the international meeting point for the ceramics industry. Digital offerings will continue to complement the trade fair.

This very year, the industry will meet at analytica China in Shanghai from November 16 to 18, 2020. The event can already report a record number of exhibitors.

Messe München GmbH D 81823 München

Setting new benchmark with virtual show

First live e-xperience with several thousand participants

True passion, real innovation, virtual experience – this was the message which ENGEL put out for the first edition of the ENGEL live e-xperience in mid-October 2020 – and ENGEL was true to its word. Several thousand customers, partners and interested parties from 90 countries took part in the virtual trade fair and online conference. The keynotes, expert talks, one-on-one meetings and machine exhibits in the virtual showroom were very well attended throughout all four live days. All presentations are still available from the media library.

„The large number of participants and the very positive feedback from our customers more than fulfilled our expectations“, says Ute Panzer, Vice President Marketing and Communications at ENGEL, drawing an extremely positive conclusion after the first live e-xperience. „We have made a quantum leap in the field of virtual exchange with customers and partners.“

Focus on personal contacts

„Even though no classic trade fairs are taking place, and restrictions apply to personal meetings, we still want to exchange ideas with our customers, partners and interested parties and present our solutions and innovations. After all, Covid-19 does not mean that we are slowing down our development activities“, says Dr. Christoph Steger, CSO of the ENGEL Group. Against this background, the injection moulding machine manufacturer developed a completely new virtual and interactive trade fair concept. Seven machine exhibits, an online spe-

cialist congress and one-on-one meetings with familiar local contacts and other experts ensured that the ENGEL live e-xperience was on a par with a physical trade fair. „We succeeded in making personal contacts the focus of attention, even in virtual format“, says Panzer. Many customers booked appointments in advance and were guided through the virtual showroom during the meetings. ENGEL provided insights into the new machine solutions and process technologies via video streams.

Both the concept and the content impressed the participants. There was also very positive feedback on the functionality of the platform and the excellent transmission quality. ENGEL had set up two streaming studios at its headquarters in Schwertberg.

Participants from 90 countries

„The reach is astounding. The participants came from 90 different countries“, says Ute Panzer, highlighting one of the main advantages of the virtual format. People who were unable to attend the event live still have the opportunity to visit the machine showroom, independently of their time zone, and to view all keynotes and expert talks via the media library. This is another benefit compared with a physical exhibition.

„Despite the very good experience, we view it as extremely important to see, and look forward to seeing, our customers, partners and interested parties in person again soon“, says Christoph Steger. „The virtual trade fair will not replace physical events in the future, but it will complement them in a very good way. We are establishing the live e-xperience as a complementary, permanent sales channel. It opens up the opportunity to present ENGEL's solutions in a way that was previously only possible at trade fairs or at one of our locations, independently of distances, time zones and restrictions“.



The first live e-xperience by ENGEL was a huge success. Dr. Christoph Steger, accompanied by moderator Mari Lang, opened the accompanying online conference on the first day of the fair, for which ENGEL had set up two streaming studios. (Picture: ENGEL)

virtual.MEDICA + virtual.COMPAMED win audiences over with their high degree of international resonance

They provided important stimuli for the healthcare economy and there is keen anticipation for the reunion in Düsseldorf in 2021

For the first time in the history of MEDICA, the world-leading medical trade fair, and the industry's number one platform for the suppliers of the medical technology industry, COMPAMED, held from 16 to 19 November 2020, took place entirely online due to the pandemic - but still won over their audiences due to their high degree of international resonance in this format too, as virtual.MEDICA and virtual.COMPAMED. Despite a very short registration period, a total of over 1,500 exhibitors took part, hailing from 63 nations. They displayed a huge variety of innovative products, amounting to over 18,300 items, in their online showrooms, and presented live programmes for the healthcare community in over 100 web sessions, which hosted 300 participants at their peak. The community showed avid interest in their drives: Over 45,000 professional visitors (unique users) from 169 nations used the virtual offers and generated 405,000 page impressions. International online visitors to the event made up 78% of the attendees.

"These numbers confirm the prominent international position that MEDICA and COMPAMED hold. They have provided the healthcare economy with significant stimuli during the height of the struggle against the pandemic, with the wide variety of themes that they took on in their specialist programme and the sheer range of exhibitor innovations on offer. Cross-country networking was boosted. The value of personal meetings was given equal importance and this was emphasised in many virtual speeches. We are all looking forward to meeting up again in Düsseldorf in 2021", concludes Wolfram Diener, CEO of Messe Düsseldorf, looking to the coming year with hope.

Exciting formats - a multitude of innovations

The Conference Area for both events provided an extensive programme, comprising 430 speakers and 360 individual programme points, and set the course for the laboratory medicine sector and the digitalisation of care processes, among other elements. Both of these subjects are particularly important in managing the pandemic. Prof. Dr. Hendrik Streeck, who provided information on the current options for testing immunity to SARS CoV-2, was one of many top speakers.

The finales of the 12th Healthcare Innovation World Cup (12th HWC) and the 9th MEDICA Start-up COMPETITION provided an electric atmosphere for digital healthcare trends, with pitch presentations from the start-up scene on the internet of medical things, health apps, diagnostics, robotics and artificial intelligence for the healthcare sector. The equal victors of the 12th HWC were: inContAlert (Germany/non-invasive measurement of bladder fullness), BeFC (France/sustainable paper-based energy source for medical devices with low power consumption) and PKvitality (France/blood sugar measurement via Smartwatch). Radiobotics from Denmark emerged as the overall winner of the Start-up Competition, with an AI-based development for radiology, which automatically detects arthritis.

Robot colleagues provide a multi-skilled helping hand in the medical sector

The highly anticipated highlights in the Exhibition Space (with online showrooms) included the announcement of the winner for the



virtual.
MEDICA

[Home](#) [Conference Area](#) [Exhibition Space](#) [Networking Plaza](#)

Join the **virtual.MEDICA 2020**

Conference Area

Exhibition Space

Networking Plaza



virtual.MEDICA + virtual.COMPAMED win audiences over

KUKA Innovation Award 2020 from KUKA, a company specialising in robotics and automation. All participating research and developer teams received the lightweight robot LBR Med for this purpose prior to this year's Medical Robotic Challenge; they then integrated this robotic component into their own concept for developing a medical product. The HIFUSK team from the renowned Scuola Superiore Sant'Anna University in Pisa, Italy won this competition. They won their audiences over with a robotic application concept for focused ultrasound surgery. This non-invasive therapy method has the potential to change cancer treatment, for example, forever. This therapy can also be carried out in outpatient care - it is gentle and the tissue ablation methods do not leave any scars.

An industry in revolution - with a platform to match

Examples such as these show that the medical technology industry is working hand in hand with developers from the research and scientific sectors, at full innovative throttle, to go head-to-head against the challenging business trends. The extent to which the corona pandemic will change the industry, and to what extent a globally functioning (and virtual) platform is needed right now for exchanging and doing good business, is shown by the new trend report: "Wie SARS-CoV-2 die Medizintechnikbranche verändert" (How SARS-CoV-2 Has Changed the Medical Technology Sector). This report was published

by the German Industry Association SPECTARIS and Roland Berger (in conjunction with the medical technology cluster MedicalMountains) within the scope of virtual.MEDICA 2020. Regardless of current business conditions and a drop in turnover due to the crisis, experts expect radical changes to occur within the market and in terms of competition in both the middle and long term. "The crisis set an irreversible chain of events into motion. Digital working models and sales, service and exhibition concepts have now taken on a prized position in many companies' strategies, and will continue to be prioritised at least at the same level as classic working methods and personal customer contacts, even after the corona pandemic", explains Jörg Mayer, Executive Director of SPECTARIS.

With regard to virtual.MEDICA, Mayer comments: "Economic activity and winning new customers have been curbed and rendered more difficult by the pandemic. Therefore, it was even more important for the medical technology industry to meet up, at least virtually, at MEDICA. Messe Düsseldorf provided the urgently needed opportunity for exchanging and transferring knowledge in the form of its many forums and conferences. It has also become clear that trade fairs are the primary drivers behind sales and marketing for the industry, even during the pandemic. virtual.MEDICA was a pioneer in this respect - both during the transition period, and it surely will be again in the future when face-to-face events are possible."

Microtechnology for combating corona

Innovations that can help overcome the pandemic quickly were the centre of attention at virtual.COMPAMED (215 exhibitors) for the supplier market for medical manufacturing. Many companies from the microtechnology sectors are active here, and have banded together under the IVAM Association for Microtechnology. The association organised the English HIGH-TECH FORUM in the Conference Area. Microfluidics is a core technology here, with respect to advancing reliable and economic rapid tests and point-of-care diagnostics. Exhibitors at virtual.COMPAMED offer a broad spectrum of services for this - from contract processing and contract production for disposable microfluidic systems to development and manufacturing of fully automated sample preparation and molecular diagnostic systems.

Dr. Thomas Dietrich, Executive Director of the IVAM, is also turning his attention to the coming year: "I think it's very sensible to encourage more virtual meetings during the corona pandemic. However, meeting in person at trade fairs and conferences remains essential for creating long-term business relationships that are built on trust, and this is simply irreplaceable. This is why we're already looking forward to seeing our customers again in person at COMPAMED 2021 in Düsseldorf."

The majority of the speeches at virtual.MEDICA and virtual.COMPAMED, along with the accompanying virtual congresses and conferences (e.g. the 43rd German Hospital Conference) will remain available to registered users for viewing online until the end of May 2021. The exhibitors' online showrooms will also be accessible up until then.

MEDICA 2021 and COMPAMED 2021 will be held from 15 - 18 November 2021 as a hybrid event. The hybrid concept consists of combining live platforms for professional visitors to the Düsseldorf trade fair centre and digital offers.



POWTECH WORLD update Online content and successful restart in China

POWTECH WORLD is a network of the world's leading trade fairs for mechanical processing technology. Alongside the leading international fair POWTECH and the PARTEC Congress in Nuremberg, the event network includes POWTECH India and IPB China. Although some events had to be postponed in recent months due to the coronavirus pandemic, IPB China was able to chalk up a successful restart. The event welcomed 109 exhibitors and some 8,800 visitors over three days from 29 to 31 July 2020, underscoring its position as the No. 1 venue for Chinese powder and bulk solids experts in the post-coronavirus era as well. Meanwhile, the webinar series POWTECH Virtual Talks got off to a successful start in the summer and has featured interesting topics like digital transformation or measuring and control technology. In addition, a new online magazine about POWTECH WORLD is fostering dialogue and networking within the POWTECH community.

Experts from China gathered at IPB China

The International Powder and Bulk Solids Processing Conference & Expo (IPB) took place from 29 to 31 July 2020 and was probably the first major event in the bulk solids industry to be held under the new circumstances. Almost all the 8,867 visitors came from within China. The organisers, NürnbergMesse China, put extensive safety and hygiene measures in place to mitigate risk at the event. Despite worldwide travel restrictions, the event was therefore able to reach visitor numbers at roughly the level of the 2018 round. The

more than 100 exhibitors also included many of the most important international brands, each represented by their local Chinese subsidiaries or partners.

Great satisfaction with live event

The post-event visitor survey shows that despite all the digital options available, exhibiting companies still attach great importance to face-to-face, personal exchanges. No less than 96 percent of exhibitors were satisfied with the event, while 65 percent, i.e. more than half of the companies

involved, have already announced that they will be rebooking for the next IPB China in 2021. The top sectors represented by IPB visitors included the chemical industry with 37 percent, followed by the food sector (23 percent), pharmaceuticals (14 percent), new energy (13 percent), glass and ceramics (7 percent) and pit and quarry/non-metallic minerals (6 percent). Darren Guo, Managing Director of NürnbergMesse China Co., Ltd. was pleased about the success of IPB 2020: "The global economy is facing tremendous challenges due to the impact of COVID-19. Under these circumstances, IPB 2020 nevertheless succeeded in offering the industry a networking and communication platform. On behalf of the organisers of IPB, I would like to express my utmost appreciation to all exhibitors, visitors and partners. Consistent with our principle 'turning ideas into value', we are creating added value for our exhibitors and the entire industry." The next IPB China will be held in Shanghai from 28 to 30 July 2021. The registration phase is already in full swing, so exhibitors can now sign up for the event and book their stands.

Virtual Talks offers professional online forum

If you want to find solutions, get new ideas and contacts and work together to develop concepts, there is no better place to do this successfully and in a concentrated format than at a trade fair or congress. But for as long as live events are still largely on hold due to travel restrictions, POWTECH is offering an online dialogue platform specifically for the powder and bulk solids processing industries: POWTECH Virtual Talks. The webinar concept is well-structured and dialogue-focused. Each round of the Virtual Talks brings together three experts representing longstanding POWTECH exhibitors or end-users. For each topic, a 15-minute TED-style presentation is followed by another 15 minutes of questions and discussion points. "We launched this format with our partner APV as an experiment in the spring of 2020. It was fascinating for us to see how well professional dialogue and interaction can also function online," says Beate Fischer, Director POWTECH at NürnbergMes-



Exciting exhibits, professional dialogue: IPB China was able to take place successfully in the summer of 2020
(© NürnbergMesse China)

Online content and successful restart in China

se. Apart from the APV (International Association for Pharmaceutical Technology), other associations involved in the programme are the VDI-GvC (VDI Association of Process and Chemical Engineering), the training institute VDI Wissensforum, and the DSIV (German Powder and Bulk Association).

The next Virtual Talk will take place on 10 November 2020 and will explore the issue of digital transformation. Speakers from Beumer, Aerzen and AZO will discuss topics like "disruption" or "artificial intelligence and small data". Other subjects will follow at monthly intervals. The POWTECH Virtual Talks will be

conducted mainly in English. For details of the next few rounds and to register free of charge please go to: www.powtech.de/en/exhibitors/virtualtalks

NürnbergMesse GmbH
D 90471 Nürnberg

Fakuma 2021: Industry and Technology Barometer in Preparation

Preparation for the 27th Fakuma international trade fair for plastics processing from 12 to 16 October 2021 is currently running at full bore. The trade fair, regarded internationally as the first port of call for injection moulding, extrusion technology, thermoforming and 3D printing, is being awaited by the industry as an indispensable live platform.

At the moment, Fakuma-Virtual is proving itself a valuable and useful instrument for presenting trade visitors with innovations covering all aspects of materials, machines, peripherals, processes, simulation, technologies and tools, as well as plastics processing. Many exhibitors are taking advantage of the opportunity to present their trade fair highlights and new developments here, and to get in touch with an expert audience. However, the virtual marketplace is neither capable of replacing the personal professional exchange between suppliers and users, nor does it have any intention of doing so. The Fakuma 2021 on-site event is and will remain indispensable, for which planning and preparation are currently running at full bore.

New Products and Systems in Preparation

For example, HNP Microsystems will make their debut at the industry highlight in 2021: the company will present a new system for dosing liquid colours in the plastic injection moulding process. "Our pump technology, which has proven itself in other industry sectors, has been integrated into a system to this end, and has been adapted to the special requirements of liquid colour dosing. Now that we've completed successful testing of the system in actual practice, we



want to unveil it," says CEO Dr. Thomas Weisener. "We look forward to meeting users at Fakuma 2021."

Austrian machinery manufacturer Fill will also be represented at Fakuma 2021 and will be using the Fakuma-Virtual platform to present new products prior to the on-site event. Fill develops complete production lines for composite components in mass production. For example, rotary table systems are ideally suited for the mass production of moulded parts made of polyurethane. In order to avoid downtime during tooling changes, the company has developed a fully automated mould-carrier/tool-changer which makes changeovers possible within the production cycle. The tools are prepared, changed and cleaned externally. Rotary tables are thus transformed into highly flexible production systems.

Protective Systems and Recycling

As an industry and technology barometer in the field of plastics processing, Fakuma will attract special attention, in particular in the wake of this pandemic year. Large numbers of projects and products have been developed in recent months in order to contain the spread of the virus – for example protective and shielding systems, as well as glasses and masks – which will be presented as polished concepts in 2021. In addition to products and solutions for preventing the spread of infection, above all issues including environmental compatibility, sustainability, efficient use of resources, circular economy and bioplastics are at the top of the list. Special emphasis will be placed on the recycling sector – the recyclates market was under considerable pressure in 2020 due to cheap new materials resulting the drop in raw material prices. As a result, recyclates have been driven out of applications which had been built up over numerous years, and the demand for PET flakes has collapsed. Not least of all within this context, the issue of PET bottle concepts and reusable packaging systems will be discussed at Fakuma 2021.

In the meantime, many companies have honed their production concepts with regard to automation, digitalisation, networking and efficiency, and have been able to implement up-to-date applications. And thus Fakuma 2021 is being especially eagerly awaited as a unique trade fair which, as a working platform for seasoned practitioners, is consistently aligned to the plastics processing sequence.

P. E. Schall GmbH & Co. KG
D 72636 Frickenhausen

CO₂ Traffic Light for Monitoring Indoor Air Quality

The CO₂ Guard 10 reliably measures the CO₂ concentration indoors. The measuring device uses an LED traffic light system to indicate when it is time to ventilate.

The CO₂ Guard 10 by E+E Elektronik precisely measures the CO₂ concentration of the indoor air. The battery-operated CO₂ traffic light is perfect for use in indoor environments such as classrooms, offices or meeting rooms. An easy-to-understand LED traffic light system with an acoustic threshold value indicator delivers information on the air quality. The CO₂ measuring device serves as a reference value encoder for demand-oriented and energy-efficient room ventilation.

Ventilation in Times of Corona

Ventilation of indoor spaces has gained enormously in importance due to the Corona pandemic. Based on current knowledge, the Corona virus (COVID-19) can spread via aerosols in enclosed spaces. To reduce the risk of infection, it is recommended that rooms be ventilated regularly. This is because the higher the proportion of fresh air is, the lower the aerosol concentration is in the indoor air. This also reduces the risk of infection through potentially viral particles.

CO₂ Concentration as an Indicator

The CO₂ concentration is a reliable indicator for the indoor air quality. In rooms with a high density of people, the CO₂ concentration rises rapidly. In addition to an increased risk of infection, a high CO₂ level leads to fatigue, lack of concentration, discomfort and headaches. Especially in schools, but also in offices or meeting rooms, it is therefore important to ventilate regularly and adequately. CO₂ traffic lights help to ensure that the room is ventilated in line with requirements and in an energy-efficient manner.

CO₂ Traffic Light for Demand-Driven Ventilation

The CO₂ Guard 10 by E+E Elektronik is a battery-powered CO₂ traffic light for use in schools, public buildings and commercial premises. The device measures the CO₂ concentration and displays the measured values in an easy-to-understand manner using a six-part LED traffic light. In addition, an acoustic warning signal is emitted as soon as the next higher threshold value is reached. The CO₂ Guard 10 therefore provides a reliable basis for an individual, demand-driven ventilation strategy.

As ventilation by opening windows incurs heat loss, especially in the winter, occupants should only ventilate for as long as needed. The CO₂ Guard 10 indicates when the CO₂ concentration has returned to the desired level and the windows can be closed. This helps to keep

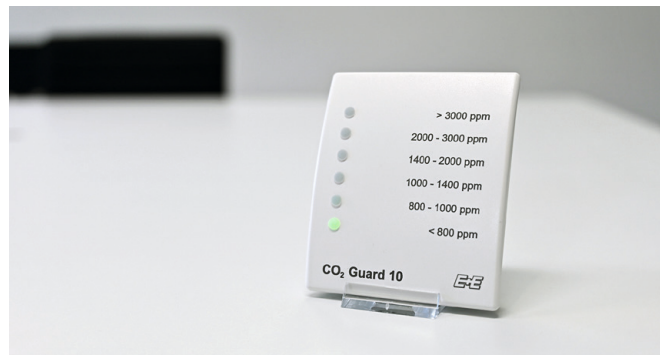

Using a six-part LED traffic light, the CO₂ Guard 10 provides information about the current CO₂ content of the indoor air. (Photo: E+E Elektronik GmbH)

heat losses low and save energy costs.

Easy Handling, State-of-the-Art Measuring Technology

The CO₂ Guard 10 is immediately ready for use. Only four standard AAA batteries are required for operation. As no external power supply is required, the CO₂ traffic light can be placed at any suitable location in the room. Besides use as a desktop unit, the device can also be wall-mounted.

The key component in the CO₂ Guard 10 is the high-quality EE895 CO₂ sensing module by E+E Elektronik. It is based on the dual wavelength NDIR measurement principle, which offers long-term stability and ensures precise and reliable CO₂ measurement values. Thanks to smart auto-calibration, the sensor is practically maintenance-free. In addition, temperature and pressure compensation ensures high CO₂ measuring accuracy, regardless of the location (sea level) and ambient conditions.

Quality from Austria

E+E Elektronik exclusively produces both the CO₂ traffic light and the EE895 sensing module, along with its sensors and measuring devices, at its Austrian headquarters in Engerwitzdorf. The company draws on many years of experience and expertise in CO₂ measuring technology. In addition to CO₂ measuring devices, E+E Elektronik also offers sensors and measuring instruments for humidity, dew point, moisture in oil, air velocity, flow, temperature and pressure. These highly accurate devices are used worldwide in a wide range of industrial and building automation applications.



E+E Elektronik GmbH
Langwiesen 7 A 4209 Engerwitzdorf
Telefon: +43 7235 605 0 Telefax: +43 7235 6058
E-Mail: info@epluse.at
Internet: <http://www.epluse.com>

Glove innovation offers protection, precision and comfort without compromise

For the most demanding scientific applications, you need a glove that offers the perfect balance of precision, protection and comfort.

Inadequate or compromised gloves can increase the risk of self-contamination or other injuries to the scientist, and the consequences can be significant:

- 30 percent of people who experience a hand injury were wearing the wrong kind of glove. (1)
- The indirect costs of an injury can be 4-10 times the amount of direct medical costs. (2)
- The average time off work for a hand injury is six days.(3)

While many gloves may look alike, not all gloves can protect the integrity of your science and the safety of your scientists. Here are some questions to ask when selecting gloves for your lab or cleanroom:

- Comfort – Are the gloves comfortable? Are they designed to minimize hand fatigue?
- Protection – What type of overall protection do the gloves provide? Do they shield the scientist from a wide range of chemicals?
- Precision – Are they strong enough to withstand the work conditions in your lab while offering tactile sensitivity, dexterity and good grip, even when wet?
- Disposal – What happens to your gloves after use? Are they sent to a landfill? Or can they be recycled?

The Kimtech™ Prizm™ difference

After extensive research and development, Kimberly-Clark Professional™ has introduced two new gloves that meet the criteria above: Kimtech™ Prizm™ multi-layered neoprene nitrile gloves and Kimtech™ Prizm™ Xtra multi-layered neoprene nitrile gloves.

The gloves were developed specifically for higher risk lab environments in the biotech, non-sterile pharmaceutical and university research fields, where science and safety must work hand-in-hand.

Designed for scientists by scientists, Kimtech™ Prizm™ gloves are crafted with a proprietary combination of polymers proven to protect against a wide range of common chemicals. An innovative technology ensures that the multi-layer neoprene-nitrile glove is one of the thinnest Type A certified gloves on the market, making it a top choice for the most demanding scientific applications.

Kimtech™ Prizm™ Gloves also offer:

- An enhanced fingertip grip helping to reduce the risk of drops and breakage, even when wet
- Certified ergonomic comfort and best-in-class dexterity, without compromising protection



- A vibrant colour combination of dark violet and dark magenta to serve as a quick cue if the laboratory glove has been cut, torn or damaged in any way during use
- Accelerator free donning layer, reducing the potential for skin irritation

The gloves are PPE Cat III certified according to PPE Regulations (EU) 2016/425 and EN ISO 374-1:2016 Type A (JKLMPT) chemical splash protection, EN ISO 374-5:2016 micro-organism and virus protection and tested according to ASTM D6978-05 against a wide range of cytotoxic drugs. They are latex and powder-free with a nitrile accelerator-free donning layer to reduce the risk of allergic reactions. Ambidextrous with a beaded cuff for strength, the gloves are available in a wide range of sizes to ensure proper fit.

A second life

In addition to these benefits, the gloves can be recycled through The RightCycle™ Programme. This groundbreaking service enables research and manufacturing facilities, universities and a variety of businesses to collect previously hard-to-recycle items, such as Kimberly-Clark Professional™ nitrile gloves and single-use apparel items, and convert them into new consumer goods.

Kimberly-Clark Europe
RH2 9QP Reigate Surrey
Vereinigtes Königreich



1 U.S. Bureau of Labor Statistics.

2 Safety Management Group.

3 U.S. Bureau of Labor Statistics.

Presenting new turbopump for ion implantation applications HiPace 2800 IT

- Highest pumping speed for light gases
- Adaption on the process due to intelligent temperature management system
- Lowest cost of ownership thanks to reliable hybrid bearing design

With the HiPace 2800 IT Pfeiffer Vacuum presents a turbopump especially dedicated for ion implantation applications. The sophisticated rotor design of the turbopump results in an optimized pumping speed for light gases. This ensures very good process adaption for ion implantation processes, where hydrogen is the most accumulating gas. With 2,600 l/s pumping speed for hydrogen the new HiPace 2800 IT is the best turbopump in its class.

The intelligent temperature management system prevents process condensation and deposition inside the pumping system. It allows setting the temperature individually to ideally support the process. The special coating of the rotor ensures robustness against all ion implantation process materials. Being based on a so-called hybrid bearing, a combination of ceramic ball bearings on the fore-vacuum side and permanently magnetic radial bearings on the high vacuum side, these HiPace turbopumps have a particularly robust bearing design. Together with the efficient coating, this forms the basis for the long life cycle and maximum up-time of the pumps.

Pfeiffer Vacuum GmbH
D 35614 Asslar

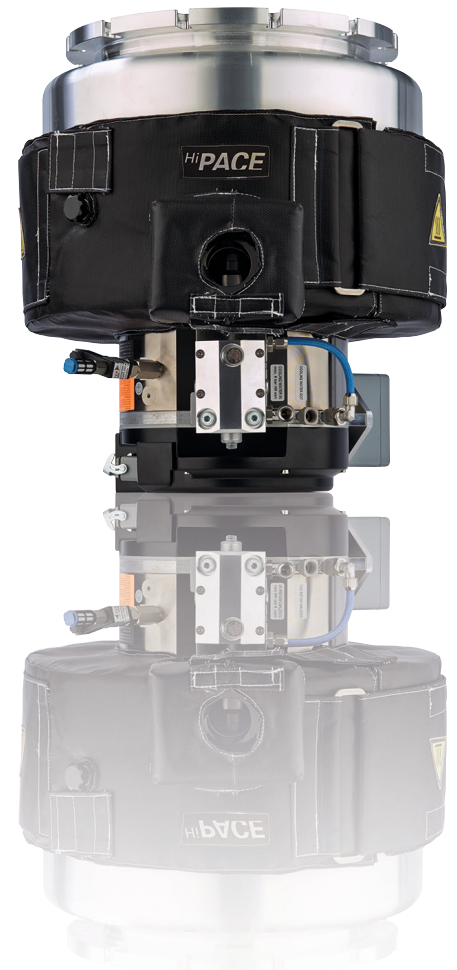

Pfeiffer Vacuum turbopumps HiPace 2800 IT

Directly controlled process solenoid valve with innovative bellows system

Valve specialist GEMÜ is launching the new GEMÜ M75 process solenoid valve with pressure compensation.

This uses an innovative double bellows principle to compensate for pressure forces. This principle means that the new valve with the highly compact coil in the available nominal sizes can be used for processes with an operating pressure of up to 6 bar. Solenoid valves are characterized by short operating times and are therefore ideal for dosing steps in mixing technology.

Whether in the chemical industry, water treatment, washing and cleaning installations or in electroplating – solenoid valves are a low-maintenance alternative to pneumatic or motorized valves, which is also cost-effective in the smaller nominal sizes.

The new directly controlled, fully pressu-

re-relieved GEMÜ M75 2/2-way process solenoid valve has a plastic encapsulated coil, available in a range of different supply voltages. The valve also helps to save resources thanks to an energy-saving reduction in holding current. Dynamic and static pressure forces are compensated for by the double bellows. Thanks to a wide range of high-quality body materials (PP, PVC and PVDF) and hermetic separation between the medium and the actuator using O-rings in various designs, the new process solenoid valve guarantees a reliable process sequence – including for corrosive media. The valve can also be used for gaseous and liquid media and is suitable for vacuum applications. The compact solenoid



GEMÜ M75 pressure-compensated process solenoid valve

valve is suitable for nominal sizes DN 8 to 15 (and can be extended to DN 20 with an adapter) for open/close applications.

GEMÜ Gebr. Müller Apparatebau GmbH & Co. KG
D 74653 Ingelfingen

The latest generation of soft seated butterfly valves

In redesigning the GEMÜ R480 Victoria series, a specialized team from the design, product management, quality management and production departments has refined a multitude of technical specifications, while also further expanding GEMÜ's manufacturing capabilities. Thanks to investments in in-house machining and coating expertise, GEMÜ now has even greater control over production processes that are essential to quality.

In-house mechanical machining for narrow mould and positional tolerances

The valve bodies are milled in one clamping position at our highly automated valve production facilities at GEMÜ Valves China. This allows precise shape and positional tolerances to be achieved. In addition, GEMÜ has greater control over butterfly valve quality as they are machined in-house. A further advantage of in-house manufacturing is the fact that the delivery times are more flexible, meaning that availability is better controlled.

Sleek disc design for higher Kv values

Thanks to its flow-optimized and sleek disc design, the redesigned GEMÜ R480 Victoria butterfly valves achieve higher flow rate factors. This reduces the pressure loss, giving the butterfly valves greater energy efficiency. The valves' constant compression on axes and shaft bearings mean that they provide great savings in operating costs as they require a lower torque for operation. Furthermore, the PTFE-coated steel bushes in the axis and shaft area further reduce the torque, thereby helping to save costs.

High-quality coating for robust valves

Having a high-quality coating does not start with selecting or applying the coating. Its pretreatment, such as sand blasting and heating, and robot technology are also crucial factors in the entire coating



GEMÜ R480 Victoria unmachined parts

process. Using the whirl sintering method, the valve bodies are immersed in a basin with epoxy powder. The powder melts on to the preheated valve body and therefore interconnects to form a robust and resistant surface.

The valves' layer thickness of at least 250 µm ensures consistent corrosion protection in accordance with ISO 12944-6 C5M, even in the liner area. The use of the whirl sintering method considerably improves the adhesion of the coating to the metal when compared to static powder coating.

Reliable and smart – GEMÜ butterfly valves are ready for Industry 4.0

Another feature of the GEMÜ R480 Victoria series is the technical optimization of their liners for improved tightness. The inclusion of additional material in the seat, axes and shaft areas – as well as a groove in the flow direction for positive liner fixing – improves the butterfly valves' sealing and resistance to slipping. A fixed point for the liner on the valve body makes it easy to change liners and to read the liner material, even when installed.

In addition, thanks to the insertion slope on the liner, it is easy to replace parts error-free when carrying out maintenance work or replacing fittings at a later stage. The GEMÜ R480 Victoria series can be used as a like-for-like replacement for the previous GEMÜ 480 Victoria series because these valves have an identical actuator flange and the same installation lengths.

Overall, the new GEMÜ butterfly valves stand out not only thanks to their service-friendly and replaceable components, but primarily because of their greater safety and efficiency. However, with the integration of an RFID chip, GEMÜ is going a step further and is prepared for Industry 4.0.

With CONEXO, GEMÜ offers an RFID system architecture that enables clear identification of wearing parts, paperless maintenance and process documentation. The CONEXO app guides maintenance technicians through the fully customizable maintenance workflows step by step.

The new GEMÜ R480 Victoria series is available in a wide range of nominal sizes, from DN 50 to DN 300, with many new features and is now available to order from GEMÜ. The new series is available in the following versions:

- GEMÜ R480 Victoria with bare shaft
- GEMÜ R487 Victoria with hand lever
- GEMÜ R481 Victoria with pneumatic actuator
- GEMÜ R488 Victoria with motorized actuator

GEMÜ Gebr. Müller Apparatebau GmbH & Co. KG
D 74653 Ingelfingen

Impressum:

cleanroom online / W.A. Schuster GmbH · Mozartstrasse 45 · D 70180 Stuttgart · Tel. +49 711 9 64 03 50 · Fax +49 711 9 64 03 66
info@reinraum.de · www.cleanroom-online.de · GF Dipl.-Designer Reinhold Schuster · Stgt, HRB 14111 · VAT DE 147811997

Original texts and images

The contributions mentioned by name are the responsibility of the particular author. Reprinting, also of extracts, are permitted only with the approval of the editor and with reference to the source. The publisher does not accept any responsibility for unsolicited manuscripts and illustrations. The publisher is granted the exclusive, spatial, temporal and content limited right to freely use the article in unchanged or edited form for all purposes as often as desired or to transfer it to third parties for use. This right of use relates to print and electric media (Internet, databases, data carriers of all kinds).